



ACESSÓRIOS
AÇO
INOXIDÁVEL

TABELA 2022

ACESSÓRIOS DE **AÇO INOXIDÁVEL**

Os aços inoxidáveis são ligas ferríticas com uma quantidade de carbono (C), inferior a 2%.

A característica principal dos aços inoxidáveis é de apresentar uma ótima resistência à corrosão, devido ao facto de um dos seus componentes principais ser o Crómio (CR), este está presente na liga com uma percentagem nunca inferior a 12%.

PRINCIPAIS GRUPOS DE AÇOS INOXIDÁVEIS

- Aços Ferríticos: Fe + Cr (12-30%) + C (0.02-0.1%).
- Aços Martensíticos: Fe + Cr (12-19%) + C (0.08-1.2%).
- Aços Austeníticos: Fe + Cr (16-28%) + C (0.02-0.1%) + Ni (6-32%)

As características dos aços austeníticos (gama presente neste catálogo)

Os aspectos que se destacam nesta categoria de aços são a óptima resistência à oxidação e as suas notáveis capacidades mecânicas a altas temperaturas.

Os aços inoxidáveis austeníticos são normalmente utilizados em todas as aplicações nas quais se requer materiais capazes de suportar exigentes condições de serviço.

Os principais são:

AISI 304 (EN1.4301): Apresenta características de elevada resistência a fadiga e uma baixa sensibilidade aos impactos, esta particularmente indicado para utilização a baixas temperaturas.

AISI 316 (EN 1.4401): O AISI 316 distingue-se do 304 pela presença de Molibdeno (Mo) na sua composição (2-3%) conferindo-lhe mais resistência à corrosão e melhorando as capacidades mecânicas a elevadas temperaturas.

O AISI 304L (EN 1.4307) e o 316L (EN 1.4404), distinguem-se dos anteriores por ter na sua composição menos Carbono (C) permitindo efectuar soldaduras a temperaturas mais altas. As restantes características são similares ao 304 e ao 316 quando utilizados a temperatura ambiente, na utilização a temperaturas mais elevadas o desempenho é ligeiramente inferior.

ACCESORIOS ROSCADOS AISI 316



90 JOELHO F/F 90°

Ø	Box		COD.	€
1/8"	400	10	I0906000	1,45
1/4"	400	10	I0906001	1,80
3/8"	290	10	I0906002	2,15
1/2"	160	10	I0906003	2,35
3/4"	80	10	I0906004	3,80
1"	50	10	I0906005	6,50
1 1/4"	24	4	I0906006	9,75
1 1/2"	18	2	I0906007	14,10
2"	10	1	I0906008	19,90
2 1/2"	6	1	I0906009	37,10
3"	3	1	I090600A	54,60
4"	1		I090600C	96,85



92 JOELHO M/F 90°

Ø	Box		COD.	€
1/8"	500	10	I0926000	1,10
1/4"	350	10	I0926001	2,35
3/8"	260	10	I0926002	2,45
1/2"	160	10	I0926003	2,90
3/4"	100	10	I0926004	4,05
1"	50	10	I0926005	7,00
1 1/4"	25	5	I0926006	10,10
1 1/2"	18	2	I0926007	12,95
2"	10	1	I0926008	22,10
2 1/2"	4	1	I0926009	42,15
3"	3	1	I092600A	58,45
4"	1		I092600C	109,60



96 JOELHO C/JUNÇÃO S/C FÊMEA

Ø	Box		COD.	€
1/2"	50	5	I0966003	9,35
3/4"	40	5	I0966004	14,35
1"	20	2	I0966005	20,40
1 1/4"	15	1	I0966006	30,05
1 1/2"	12	1	I0966007	40,65
2"	6	1	I0966008	59,55



98 JOELHO C/JUNÇÃO S/C M/F

Ø	Box		COD.	€
1/2"	50	5	I0986003	11,20
3/4"	30	5	I0986004	16,30
1"	14	2	I0986005	21,80
1 1/4"	12	1	I0986006	33,90
1 1/2"	8	1	I0986007	46,95
2"	6	1	I0986008	66,30



120 JOELHO SIMPLES 45°

Ø	Box		COD.	€
1/4"	400	10	I1206001	1,50
3/8"	300	10	I1206002	2,15
1/2"	150	5	I1206003	2,50
3/4"	90	5	I1206004	3,50
1"	60	5	I1206005	5,95
1 1/4"	30	1	I1206006	9,40
1 1/2"	20	1	I1206007	12,15
2"	12	1	I1206008	18,05
2 1/2"	8	1	I1206009	47,90
3"	4	1	I120600A	62,85



121 JOELHO SIMPLES M/F 45°

Ø	Box		COD.	€
1/4"	400	10	I1216001	1,50
3/8"	200	10	I1216002	2,10
1/2"	150	5	I1216003	2,70
3/4"	90	5	I1216004	3,95
1"	60	5	I1216005	6,85
1 1/4"	30	1	I1216006	9,60
1 1/2"	20	1	I1216007	12,60
2"	12	1	I1216008	20,40
2 1/2"	8	1	I1216009	48,85
3"	4	1	I121600A	63,30



130 TÊ

Ø		COD.	€
1/8"	380 10	I1306000	1,60
1/4"	250 10	I1306001	2,35
3/8"	160 10	I1306002	3,05
1/2"	100 5	I1306003	3,55
3/4"	50 5	I1306004	5,55
1"	30 5	I1306005	9,00
1 1/4"	18 2	I1306006	13,20
1 1/2"	14 2	I1306007	18,05
2"	10 1	I1306008	25,40
2 1/2"	4 1	I1306009	46,40
3"	2 1	I130600A	72,10
4"	1	I130600C	128,75



130R TÊ DE REDUÇÃO

Ø		COD.	€
1/2" x 3/8" x 1/2"	120 5	I1306323	5,50
3/4" x 1/2" x 3/4"	60 5	I1306434	6,55
1" x 1/2" x 1"	40 5	I1306535	7,20
1" x 3/4" x 1"	30 5	I1306545	8,35
1" x 1" x 1/2"	30 5	I1306553	8,60



241 PORCA DE REDUÇÃO M/F

Ø		COD.	€
1/4" x 1/8"	650 10	I2416010	1,25
3/8" x 1/8"	580 10	I2416020	1,25
3/8" x 1/4"	580 10	I2416021	1,60
1/2" x 1/8"	500 10	I2416030	2,25
1/2" x 1/4"	380 10	I2416031	2,10
1/2" x 3/8"	400 10	I2416032	1,80
3/4" x 1/4"	240 5	I2416041	3,20
3/4" x 3/8"	250 5	I2416042	3,05
3/4" x 1/2"	240 5	I2416043	2,70
1" x 3/8"	120 10	I2416052	3,50
1" x 1/2"	140 5	I2416053	3,35
1" x 3/4"	140 5	I2416054	3,50
1 1/4" x 1/2"	100 5	I2416063	5,70
1 1/4" x 3/4"	80 5	I2416064	5,55
1 1/4" x 1"	100 5	I2416065	4,90
1 1/2" x 1/2"	60 5	I2416073	7,60
1 1/2" x 3/4"	60 5	I2416074	7,40
1 1/2" x 1"	70 2	I2416075	7,10
1 1/2" x 1 1/4"	70 2	I2416076	5,60
2" x 1/2"	35 5	I2416083	12,35
2" x 3/4"	35 5	I2416084	12,35
2" x 1"	30 5	I2416085	12,25
2" x 1 1/4"	30 5	I2416086	11,90
2" x 1 1/2"	30 2	I2416087	10,55
2 1/2" x 1"	24 2	I2416095	25,05
2 1/2" x 1 1/4"	24 4	I2416096	21,05
2 1/2" x 1 1/2"	24 2	I2416097	21,70
2 1/2" x 2"	24 2	I2416098	17,85
3" x 2"	16 1	I24160A8	34,25
3" x 2 1/2"	16 1	I24160A9	31,75
4" x 2"	8 1	I24160C8	71,70
4" x 2 1/2"	8 1	I24160C9	73,40
4" x 3"	8 1	I24160CA	64,10



180 CRUZETA

Ø		COD.	€
1/8"	250 10	I1806000	3,90
1/4"	160 10	I1806001	4,90
3/8"	120 10	I1806002	5,00
1/2"	60 10	I1806003	5,15
3/4"	36 6	I1806004	7,20
1"	20 5	I1806005	11,60
1 1/4"	16 4	I1806006	20,50
1 1/2"	12 4	I1806007	23,35
2"	6 2	I1806008	34,95
2 1/2"	3 1	I1806009	61,30
3"	2 1	I180600A	103,55
4"	1	I180600C	202,80



240 UNIÃO DE REDUÇÃO

Ø		COD.	€
1/4" x 1/8"	300 10	I2406010	2,35
3/8" x 1/4"	300 10	I2406021	2,50
1/2" x 1/4"	150 10	I2406031	2,50
1/2" x 3/8"	200 10	I2406032	2,50
3/4" x 1/4"	140 10	I2406041	4,80
3/4" x 1/2"	120 5	I2406043	3,80
1" x 1/2"	90 5	I2406053	4,90
1" x 3/4"	70 5	I2406054	4,90
1 1/4 x 3/4"	60 5	I2406064	7,80
1 1/4" x 1"	40 5	I2406065	7,80
1 1/2" x 1"	40 5	I2406075	8,75
1 1/2" x 1 1/4"	30 5	I2406076	10,25
2" x 1"	30 5	I2406085	14,60
2" x 1 1/4"	25 5	I2406086	14,60
2" x 1 1/2"	25 5	I2406087	15,45
2 1/2" x 2"	12 2	I2406098	23,10
3" x 2"	12 2	I24060A8	41,65

2



1

245 CASQ. DUPLO REDUÇÃO M/M



270 UNIÃO SIMPLES

Ø	📦		COD.	€
1/4" x 1/8"	520	10	I2456010	1,15
3/8" x 1/8"	400	10	I2456020	1,95
3/8" x 1/4"	400	10	I2456021	1,80
1/2" x 1/4"	280	10	I2456031	3,50
1/2" x 3/8"	200	10	I2456032	3,35
3/4" x 1/4"	200	10	I2456041	3,55
3/4" x 3/8"	100	10	I2456042	3,95
3/4" x 1/2"	180	10	I2456043	4,05
1" x 1/2"	100	5	I2456053	4,05
1" x 3/4"	100	5	I2456054	5,90
1 1/4" x 1/2"	60	5	I2456063	7,00
1 1/4" x 3/4"	70	5	I2456064	7,00
1 1/4" x 1"	60	5	I2456065	7,00
1 1/2" x 1/2"	45	3	I2456073	8,55
1 1/2" x 3/4"	54	3	I2456074	8,55
1 1/2" x 1"	40	2	I2456075	8,55
1 1/2" x 1 1/4"	36	2	I2456076	8,55
2" x 1"	28	2	I2456085	13,35
2" x 1 1/4"	30	2	I2456086	13,35
2" x 1 1/2"	26	2	I2456087	13,35
2 1/2" x 1"	12	2	I2456095	31,75
2 1/2" x 1 1/4"	12	2	I2456096	30,50
2 1/2" x 1 1/2"	12	2	I2456097	28,65
2 1/2" x 2"	20	1	I2456098	28,05
3" x 2"	10	1	I24560A8	39,10
3" x 2 1/2"	10	1	I24560A9	36,75

Ø	📦		COD.	€
1/8"	800	10	I2706000	1,35
1/4"	450	10	I2706001	1,50
3/8"	400	10	I2706002	1,95
1/2"	240	10	I2706003	2,75
3/4"	180	5	I2706004	3,90
1"	80	5	I2706005	4,95
1 1/4"	50	2	I2706006	7,20
1 1/2"	40	2	I2706007	8,35
2"	24	1	I2706008	12,00
2 1/2"	12	1	I2706009	19,20
3"	8	1	I270600A	26,50
4"	4	1	I270600C	45,20



280 CASQUILHO DUPLO

Ø	📦		COD.	€
1/8"	700	10	I2806000	1,30
1/4"	500	10	I2806001	1,95
3/8"	400	10	I2806002	2,25
1/2"	240	10	I2806003	2,35
3/4"	120	5	I2806004	3,30
1"	80	5	I2806005	4,90
1 1/4"	45	3	I2806006	7,35
1 1/2"	30	2	I2806007	10,10
2"	20	1	I2806008	13,25
2 1/2"	12	1	I2806009	28,20
3"	8	1	I280600A	38,50
4"	4	1	I280600C	58,35



285 PASSAMUROS

Ø	📦		COD.	€
3/8"	100	5	I2856002	17,35
1/2"	100	5	I2856003	19,50
3/4"	60	5	I2856004	23,10
1"	40	5	I2856005	26,40
1 1/4"	20	2	I2856006	35,80
1 1/2"	16	2	I2856007	43,00
2"	16	2	I2856008	62,10



300 TAMPÃO FÊMEA

Ø	📦		COD.	€
1/8"	600	10	I3006000	1,10
1/4"	600	10	I3006001	1,20
3/8"	400	10	I3006002	1,30
1/2"	250	5	I3006003	2,10
3/4"	180	5	I3006004	2,40
1"	120	5	I3006005	4,10
1 1/4"	60	3	I3006006	6,10
1 1/2"	46	2	I3006007	8,15
2"	30	1	I3006008	13,25
2 1/2"	20	1	I3006009	26,05
3"	12	1	I300600A	31,50
4"	8	1	I300600C	48,55



290 TAMPÃO MACHO

Ø	📦		COD.	€
1/8"	800	10	I2906000	1,20
1/4"	600	10	I2906001	1,20
3/8"	500	10	I2906002	1,35
1/2"	300	10	I2906003	1,95
3/4"	200	5	I2906004	2,35
1"	140	5	I2906005	3,55
1 1/4"	81	3	I2906006	5,65
1 1/2"	60	3	I2906007	6,85
2"	30	1	I2906008	10,50
2 1/2"	24	1	I2906009	20,05
3"	16	1	I290600A	28,10
4"	8	1	I290600C	43,00

312 BATENTE REBAIXADO

315 CASQUILHO M P/ MANGUEIRA

Ø			COD.	€
1/8"	1000	10	I3106000	1,05
1/4"	800	10	I3106001	1,05
3/8"	600	10	I3106002	1,05
1/2"	400	5	I3106003	1,60
3/4"	300	5	I3106004	2,05
1"	200	5	I3106005	3,30
1 1/4"	120	3	I3106006	4,90
1 1/2"	100	2	I3106007	6,90
2"	10	1	I3106008	10,10
2 1/2"	25	1	I3106009	16,05
3"	20	1	I310600A	21,70
4"	10	1	I310600C	38,60

Ø			COD.	€
1/8" x 8 mm.	500	10	I3156000	2,05
1/4" x 9 mm.	500	10	I3156001	2,25
3/8" x 11 mm.	350	10	I3156002	2,80
1/2" x 15 mm.	200	10	I3156003	3,50
3/4" x 20 mm.	120	5	I3156004	5,55
1" x 27 mm.	60	5	I3156005	7,50
1 1/4" x 33 mm.	40	2	I3156006	11,55
1 1/2" x 40 mm.	35	1	I3156007	15,65
2" x 53 mm.	15	1	I3156008	22,85
2 1/2" x 66 mm.	10	1	I3156009	33,15
3" x 80 mm.	8	1	I315600A	47,05
4" x 105 mm.	2	1	I315600C	82,35

330 JUNÇÃO FÊMEA S/D

331 JUNÇÃO M/F S/D

Ø			COD.	€
1/4"	120	10	I3306001	6,55
3/8"	100	10	I3306002	8,10
1/2"	100	10	I3306003	8,30
3/4"	60	10	I3306004	11,25
1"	40	10	I3306005	15,65
1 1/4"	20	5	I3306006	25,05
1 1/2"	18	3	I3306007	29,70
2"	16	2	I3306008	47,65
2 1/2"	6	2	I3306009	79,15
3"	4	1	I330600A	107,35
4"	2	1	I330600C	163,85

Ø			COD.	€
1/4"	200	10	I3316001	6,55
3/8"	150	10	I3316002	8,85
1/2"	100	10	I3316003	9,00
3/4"	60	5	I3316004	13,15
1"	42	3	I3316005	18,05
1 1/4"	21	3	I3316006	28,20
1 1/2"	16	2	I3316007	32,95
2"	10	1	I3316008	52,05
2 1/2"	6	1	I3316009	85,65
3"	4	1	I331600A	119,60
4"	2	1	I331600C	181,60

340 JUNÇÃO FÊMEA S/C

341 JUNÇÃO M/F S/C

Ø			COD.	€
1/8"	250	10	I3406000	4,80
1/4"	200	10	I3406001	6,50
3/8"	150	10	I3406002	7,95
1/2"	100	10	I3406003	8,05
3/4"	60	5	I3406004	9,55
1"	42	3	I3406005	14,25
1 1/4"	21	3	I3406006	22,50
1 1/2"	16	2	I3406007	28,60
2"	16	1	I3406008	37,05
2 1/2"	6	1	I3406009	65,35
3"	4	1	I340600A	86,40
4"	2	1	I340600C	125,30

Ø			COD.	€
1/8"	250	10	I3416000	7,20
1/4"	200	10	I3416001	8,40
3/8"	120	10	I3416002	8,95
1/2"	100	10	I3416003	9,40
3/4"	50	5	I3416004	11,20
1"	30	3	I3416005	16,95
1 1/4"	21	3	I3416006	26,40
1 1/2"	16	2	I3416007	34,40
2"	10	1	I3416008	44,30
2 1/2"	5	1	I3416009	74,50
3"	2	1	I341600A	93,80
4"	1	1	I341600C	148,35



JUNTA PLANA EM PTFE PARA FIG 300 E 331



Ø			COD.	€
1/4"	100	10	I33J0001	0,55
3/8"	100	10	I33J0002	0,55
1/2"	100	10	I33J0003	0,70
3/4"	100	10	I33J0004	0,75
1"	100	10	I33J0005	1,05
1 1/4"	100	10	I33J0006	1,45
1 1/2"	100	10	I33J0007	2,55
2"	100	10	I33J0008	3,50
2 1/2"	100	10	I33J0009	5,00
3"	100	10	I33J000A	5,00
4"	100	10	I33J000C	6,90



531 ROSCA EXTERIOR (UNIÃO)

Ø			COD.	€
1/4"	1000	10	I5316001	1,75
3/8"	600	10	I5316002	2,15
1/2"	350	5	I5316003	2,75
3/4"	200	5	I5316004	2,85
1"	140	5	I5316005	4,20
1 1/4"	80	2	I5316006	5,95
1 1/2"	60	2	I5316007	6,15
2"	18	1	I5316008	8,40



530 BOBINE ROSCADA

Ø			COD.	€
1/8" x 40 mm.	800	10	I5306000	1,95
1/4" x 40 mm.	500	10	I5306001	2,00
3/8" x 40 mm.	400	10	I5306002	2,05
3/8" x 80 mm.	280	10	I5362080	4,00
3/8" x 150 mm.	120	10	I5362150	4,35
1/2" x 60 mm.	180	10	I5306003	2,85
1/2" x 80 mm.	210	10	I5363080	4,00
1/2" x 120 mm.	200	10	I5363120	4,65
1/2" x 150 mm.	110	10	I5363150	5,40
3/4" x 60 mm.	120	10	I5306004	4,15
3/4" x 100 mm.	60	10	I5364100	4,90
3/4" x 120 mm.	70	10	I5364120	5,70
3/4" x 150 mm.	60	10	I5364150	6,50
3/4" x 200 mm.	50	10	I5364200	8,40
1" x 40 mm.	140	10	I5365040	4,00
1" x 60 mm.	120	5	I5306005	4,75
1" x 80 mm.	70	10	I5365080	5,95
1" x 100 mm.	60	10	I5365100	6,40
1" x 150 mm.	40	10	I5365150	9,40
1" x 200 mm.	30	10	I5365200	11,20
1 1/4" x 80 mm.	40	2	I5306006	8,50
1 1/4" x 100 mm.	40	10	I5366100	7,40
1 1/4" x 150 mm.	25	1	I5366150	10,80
1 1/2" x 80 mm.	25	1	I5306007	8,95
1 1/2" x 150 mm.	20	1	I5367150	23,50
2" x 60 mm.	30	10	I5368060	11,95
2" x 100 mm.	18	1	I5306008	14,50
2" x 150 mm.	12	1	I5368150	25,10
2 1/2" x 100 mm.	10	1	I5306009	24,20
3" x 120 mm.	5	1	I530600A	34,15
4" x 120 mm.	2	1	I530600C	68,35



600 BOBINE ROSCAR/SOLDAR M.

Ø			COD.	€
1/8" x 30 mm.	1200	10	I6006000	1,25
1/4" x 30 mm.	500	10	I6006001	1,35
3/8" x 30 mm.	500	10	I6006002	1,45
1/2" x 35 mm.	300	5	I6006003	1,95
3/4" x 40 mm.	180	5	I6006004	2,55
1" x 40 mm.	120	5	I6006005	3,75
1 1/4" x 50 mm.	60	3	I6006006	5,55
1 1/2" x 50 mm.	40	2	I6006007	6,35
2" x 50 mm.	30	1	I6006008	8,80
2 1/2" x 60 mm.	18	1	I6006009	16,60
3" x 70 mm.	12	1	I600600A	25,00
4" x 80mm.	4	1	I600600C	40,15



700 ENTRONQUE ROSCA - MANGUERA

Ø			COD.	€
1/4" x 70 mm.	400	10	I7001070	2,50
3/8" x 70 mm.	250	10	I7002070	3,10
1/2" x 70 mm.	180	10	I7003070	3,90
3/4" x 70 mm.	120	10	I7004070	4,80
1" x 70 mm.	90	5	I7005070	6,40
1 1/4" x 70 mm.	40	5	I7006070	8,40
1 1/2" x 100 mm.	25	5	I7007100	12,35
2" x 100 mm.	20	1	I7008100	16,40



800 ENTRONQUE MANGUERA - MANGUERA

Ø			COD.	€
1/4" x 66 mm.	300	10	I8001066	2,50
3/8" x 76 mm.	250	10	I8002076	3,25
1/2" x 86 mm.	160	10	I8003086	4,40
3/4" x 100 mm.	80	10	I8004100	6,00
1" x 114 mm.	50	5	I8005114	8,95
1 1/4" x 114 mm.	30	5	I8006114	11,75
1 1/2" x 122 mm.	25	5	I8007122	14,85
2" x 130 mm.	15	1	I8008130	20,10

ABRAÇADEIRAS

**ABRAÇADEIRA INOX AISI 304
M8/M10**

ESPESSURA DA BANDA 2,5 mm.

POLEGADAS	mm.	TUERCA		COD.	€
3/8"	16-18	M8	150 2	IRAF5102	2,35
1/2"	20-22	M8	100 2	IRAF5103	2,45
3/4"	25-28	M8	100 2	IRAF5104	2,65
1"	31-34	M8	100 2	IRAF5105	2,75
1 1/4"	39-43	M8	100 2	IRAF5106	2,90
1 1/2"	45-48.5	M8	100 2	IRAF5107	3,00
2"	58-61	M8	100 2	IRAF5108	3,35
2 1/2"	73-76.5	M10	50 2	IRAF5109	5,50
3"	86-89	M10	50 2	IRAF510A	6,20
4"	110-115	M10	50 2	IRAF510C	6,50

**ABRAÇADEIRA INOX AISI 304
M8/M10 COM BUCHA E PARAFUSO**

ESPESSURA DA BANDA 2,5 mm.

POLG.	mm.	PARAFUSO	BUCHA		COD.	€
3/8"	16-18	M8x100	10x50	100 2	IRAF5502	3,55
1/2"	20-22	M8x100	10x50	100 2	IRAF5503	3,70
3/4"	25-28	M8x100	10x50	100 2	IRAF5504	3,95
1"	31-34	M8x100	10x50	100 2	IRAF5505	4,05
1 1/4"	39-43	M8x100	10x50	100 2	IRAF5506	4,25
1 1/2"	45-48.5	M8x100	10x50	50 2	IRAF5507	4,40
2"	58-61	M8x100	10x50	50 2	IRAF5508	5,05
2 1/2"	73-76.5	M10x120	12x60	20 2	IRAF5509	7,40
3"	86-89	M10x120	12x60	20 2	IRAF550A	8,30
4"	110-115	M10x120	12x60	20 2	IRAF550C	9,55

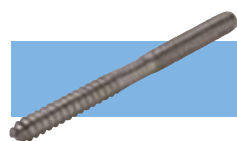
PARAFUSO AISI 304 ROSCA DUPLA

PORCA	mm.		COD.	€
M8	90	500 10	IRAFTD08	1,20
M10	120	500 10	IRAFTD10	2,35

ABRAÇADEIRAS EM "U"

**ABRAÇADEIRA EM "U"
INOX AISI 304**

Inclui porcas e anilhas. Nas medidas M6 e M8 as porcas e anilhas vêm montadas.

Ø TUBO	POLG.	PORCA		COD.	€ 100 UDS.
17,1	3/8"	M6	100 10	RFABI202	69,00
21,3	1/2"	M6	100 10	RFABI203	76,00
26,9	3/4"	M6	100 10	RFABI204	85,00
33,7	1"	M6	100 10	RFABI205	98,00
42,2	1 1/4"	M6	100 5	RFABI206	101,00
48,3	1 1/2"	M8	50 5	RFABI207	205,00
54,0	-	M8	50 5	RFABI254	215,00
60,3	2"	M8	50 5	RFABI208	226,00
76,1	2 1/2"	M8	25 5	RFABI20A	273,00
84,0	-	M8	25 5	RFABI284	284,00
88,9	3"	M8	25 5	RFABI20B	305,00
104,0	-	M10	20 2	RFABI210	536,00
114,4	4"	M10	20 2	RFABI20D	604,00
129,0	-	M10	20 2	RFABI213	667,00
139,7	5"	M10	20 2	RFABI20E	714,00
154,0	-	M10	16 2	RFABI215	809,00
168,3	6"	M10	16 2	RFABI20F	893,00
204,0	-	M10	10 2	RFABI220	1.015,00
219,1	8"	M10	10 2	RFABI20H	1.100,00
254,0	-	M10	6 2	RFABI225	1.310,00
304,0	-	M10	6 2	RFABI230	1.490,00

ACESSÓRIOS PARA INDUSTRIA ALIMENTAR NW - DIN 11851



CASQUILHO

Ø		COD. AISI 304	€	COD. AISI 316	€
15	700 10			I3816003	2,80
20	400 10			I3816004	4,35
25	225 5	I3814005	3,70	I3816005	5,00
32	180 5	I3814006	4,80	I3816006	5,10
40	150 5	I3814007	5,25	I3816007	6,00
50	90 5	I3814008	7,30	I3816008	8,05
65	48 2	I3814009	10,35	I3816009	12,35
80	28 2	I381400A	13,25	I381600A	16,75
100	20 2	I381400C	19,60	I381600C	26,65
125	20 1			I381600D	39,60
150	16 1			I381600E	52,10



PORCA ROSCADA AISI 304

Ø		COD.	€
15	300 10	I3744003	6,15
20	180 10	I3744004	7,35
25	150 5	I3744005	7,35
32	125 5	I3744006	7,55
40	80 5	I3744007	8,20
50	55 5	I3744008	9,25
65	30 2	I3744009	14,40
80	16 2	I374400A	21,80
100	14 2	I374400C	25,40
125	14 1	I374400D	43,20
150	10 1	I374400E	66,45



LIGAÇÃO MACHO

Ø		COD. AISI 304	€	COD. AISI 316	€
15	500 10			I3806003	4,10
20	300 10			I3806004	6,15
25	160 5	I3804005	6,15	I3806005	6,30
32	120 5	I3804006	6,50	I3806006	7,20
40	75 5	I3804007	7,75	I3806007	8,70
50	60 5	I3804008	9,35	I3806008	11,35
65	36 2	I3804009	14,20	I3806009	17,60
80	24 2	I380400A	20,50	I380600A	26,30
100	12 2	I380400C	25,10	I380600C	35,95
125	15 1			I380600D	63,95
150	10 1			I380600E	94,05



PORCA CEGA AISI 304 COM JUNTA EPDM E CADEADO

Ø		COD.	€
25	85 5	I3834005	17,20
32	60 5	I3834006	21,35
40	60 5	I3834007	24,10
50	50 5	I3834008	29,70
65	36 2	I3834009	42,60
80	20 2	I383400A	54,25
100	12 2	I383400C	68,55



JUNTA PARA ACESSÓRIO

Ø		COD. EPDM	€	COD. NBR	€
15	300 10	IJAL0003	0,50	IJALN003	0,50
20	300 10	IJAL0004	0,50	IJALN004	0,50
25	680 10	IJAL0005	0,60	IJALN005	0,60
32	900 10	IJAL0006	0,60	IJALN006	0,60
40	700 10	IJAL0007	0,60	IJALN007	0,60
50	700 10	IJAL0008	0,65	IJALN008	0,70
65	600 10	IJAL0009	1,10	IJALN009	1,10
80	600 10	IJAL000A	1,15	IJALN00A	1,20
100	500 10	IJAL000C	1,65	IJALN00C	2,50
125	- 6	IJAL000D	1,95	IJALN00D	2,55
150	- 5	IJAL000E	3,95	IJALN00E	4,15



JUNTA EPDM PARA PORCA CEGA

Ø		COD.	€
25	680 10	IJALCE05	1,95
32	900 10	IJALCE06	2,00
40	700 10	IJALCE07	2,15
50	700 10	IJALCE08	2,70
65	300 10	IJALCE09	3,15
80	300 10	IJALCE0A	3,55
100	250 10	IJALCE0C	4,50

ACESSÓRIOS CLAMP EM INOX

ABRAÇADEIRA CLAMP AISI 304

Ø	POLG.	CASQUILHO CLAMP mm.		COD.	€
	1/2" - 3/4"	25,0	150 1	IRFC4008	7,60
10-15-20		34,0	130 1	IRFC4010	8,35
25-32-40	1" - 1.5"	50,5	100 1	IRFC4025	9,95
50	2"	64,0	100 1	IRFC4050	11,80
	2 1/2"	77,5	80 1	IRFC4060	13,00
65	3"	91,0	70 1	IRFC4065	14,45
80	3.5"	106,0	50 1	IRFC4080	16,15
100	4"	119,0	40 1	IRFC4100	17,40

TAMPÃO CLAMP CEGO AISI 316L

Ø	STANDARD	DIÂM. EXT TUBO		COD.	€
1/2" - 3/4"	3A	25,4	800 20	IRCB6009	4,45
10 - 15 - 20	DIN	34,0	800 20	IRCB6010	5,00
25 - 32 - 40	DIN	50,5	300 20	IRCB6025	5,60
50	DIN	64,0	200 20	IRCB6050	8,10
2 1/2"	3A	77,5	100 5	IRCB6060	9,95
65	DIN	91,0	60 5	IRCB6065	12,45
80	DIN	106,0	60 5	IRCB6080	16,80
100	DIN	119,0	40 5	IRCB6100	24,25

CASQUILHO CLAMP SOLDAR AISI 316L

Ø	STANDARD	DIÂM. EXT TUBO	DIÂM. EXT. CLAMP	COMPRIMENTO		COD.	€
1/2"	3A	12,7	25,4	28,6	350 10	IRCC6009	5,25
10	DIN	12,0	34,0	21,5	350 10	IRCC6010	5,25
15	DIN	18,0	34,0	21,5	350 10	IRCC6015	5,25
3/4"	3A	19,0	25,4	28,6	350 10	IRCC6016	5,10
20	DIN	22,0	34,0	21,5	250 10	IRCC6020	4,95
1"	3A	25,4	50,5	28,6	150 10	IRCC6022	6,45
25	DIN	28,0	50,5	21,5	180 10	IRCC6025	4,90
32	DIN	34,0	50,5	21,5	180 10	IRCC6032	4,85
1 1/2"	3A	38,1	50,5	28,6	150 10	IRCC6035	6,35
40	DIN	40,0	50,5	21,5	180 10	IRCC6040	4,80
2"	3A	50,8	64,0	28,6	120 10	IRCC6048	7,70
50	DIN	52,0	64,0	21,5	150 10	IRCC6050	6,35
2 1/2"	3A	63,5	77,5	28,6	70 10	IRCC6060	8,70
65	DIN	70,0	91,0	21,5	70 5	IRCC6065	10,10
3"	3A	76,2	91,0	28,6	40 5	IRCC6073	12,65
80	DIN	85,0	106,0	21,5	60 5	IRCC6080	12,45
4"	3A	101,6	119,0	28,6	25 5	IRCC6097	19,00
100	DIN	104,0	119,0	21,5	30 5	IRCC6100	14,90



JUNTA PARA CASQUILHO CLAMP

Ø	STANDARD	DIÂM. INT.	DIÂM. EXT.		COD. EPDM	€	COD. NBR	€
1/2"	3A	9,9	25,4	800 10	IRCJE009	0,65	IRCJN009	0,75
10	DIN	10,2	34,0	800 10	IRCJE010	0,65	IRCJN010	0,75
15	DIN	16,2	34,0	800 10	IRCJE015	0,65	IRCJN015	0,75
3/4"	3A	16,2	25,4	800 10	IRCJE016	0,65	IRCJN016	0,75
20	DIN	20,2	34,0	600 10	IRCJE020	0,65	IRCJN020	0,75
1"	3A	22,8	50,5	600 10	IRCJE022	1,00	IRCJN022	1,25
25	DIN	26,2	50,5	500 10	IRCJE025	1,00	IRCJN025	1,25
32	DIN	32,2	50,5	500 10	IRCJE032	1,00	IRCJN032	1,25
1 1/2"	3A	35,8	50,5	500 10	IRCJE035	1,00	IRCJN035	1,25
40	DIN	38,2	50,5	500 10	IRCJE040	1,00	IRCJN040	1,25
2"	3A	48,8	64,0	400 10	IRCJE048	1,25	IRCJN048	1,65
50	DIN	50,2	64,0	400 10	IRCJE050	1,25	IRCJN050	1,65
2 1/2"	3A	60,5	77,5	350 10	IRCJE060	1,75	IRCJN060	2,25
65	DIN	66,2	91,0	350 5	IRCJE065	2,00	IRCJN065	2,45
3"	3A	73,1	91,0	150 5	IRCJE073	2,00	IRCJN073	2,45
80	DIN	81,2	106,0	150 5	IRCJE080	2,45	IRCJN080	3,15
4"	3A	97,8	119,0	125 5	IRCJE097	2,95	IRCJN097	3,75
100	DIN	100,2	119,0	125 5	IRCJE100	2,95	IRCJN100	3,75

ACESSÓRIOS PARA SOLDAR – INDUSTRIA ALIMENTAR - DIN 11852



CURVA 90°

DN	ESPESS. mm.	DIAM. EXT. mm.	R mm.		AISI 304		AISI 316L	
					COD.	€	COD.	€
10	1,5	12	26,0	10			IAC96010	4,60
15	1,5	18	35,0	10			IAC96015	5,10
20	1,5	22	40,0	9			IAC96020	5,35
25	1,5	28	50,0	7	IAC94025	4,75	IAC96025	6,05
32	1,5	34	55,0	5	IAC94032	5,80	IAC96032	7,45
40	1,5	40	60,0	5	IAC94040	6,70	IAC96040	8,70
50	1,5	52	70,0	4	IAC94050	8,55	IAC96050	11,00
65	2,0	70	80,0	3	IAC94065	13,80	IAC96065	16,90
80	2,0	85	90,0	2	IAC94080	19,60	IAC96080	24,60
100	2,0	104	100,0	1	IAC94100	29,90	IAC96100	34,75
125	2,0	129	187,5	1			IAC96125	78,10
150	2,0	154	225,0	1			IAC96150	104,45



TÊ

DN	ESPESS. mm.	DIAM. EXT. mm.	R mm.		AISI 304		AISI 316L	
					COD.	€	COD.	€
10	1,5	12	26,0	4			IATL6010	9,20
15	1,5	18	35,0	4			IATL6015	9,55
20	1,5	22	40,0	4			IATL6020	10,95
25	1,5	28	50,0	4	IATL4025	8,75	IATL6025	10,95
32	1,5	34	55,0	4	IATL4032	10,50	IATL6032	12,15
40	1,5	40	60,0	4	IATL4040	12,00	IATL6040	13,35
50	1,5	52	70,0	3	IATL4050	14,90	IATL6050	18,80
65	2,0	70	80,0	3	IATL4065	22,40	IATL6065	28,75
80	2,0	85	90,0	2	IATL4080	30,05	IATL6080	38,85
100	2,0	104	100,0	1	IATL4100	41,05	IATL6100	51,90
125	2,0	129	187,5	1			IATL6125	92,45
150	2,0	154	225,0	1			IATL6150	156,80



REDUÇÃO CONCÊNTRICA
AISI 316L

DN	ESPESSURA mm.		COD.	€
15 x 10	1,5	10	IARC6032	4,75
20 x 10	1,5	10	IARC6042	5,15
20 x 15	1,5	10	IARC6043	4,80
25 x 10	1,5	10	IARC6052	6,90
25 x 15	1,5	10	IARC6053	6,25
25 x 20	1,5	10	IARC6054	6,80
32 x 15	1,5	10	IARC6063	7,70
32 x 20	1,5	10	IARC6064	7,10
32 x 25	1,5	10	IARC6065	6,90
40 x 20	1,5	10	IARC6074	8,30
40 x 25	1,5	10	IARC6075	7,70
40 x 32	1,5	10	IARC6076	7,50
50 x 25	1,5	10	IARC6085	9,65
50 x 32	1,5	10	IARC6086	8,75
50 x 40	1,5	10	IARC6087	8,60
65 x 32	2,0	1	IARC6096	15,90
65 x 40	2,0	1	IARC6097	13,25
65 x 50	2,0	1	IARC6098	11,45
80 x 40	2,0	1	IARC60A7	19,90
80 x 50	2,0	1	IARC60A8	17,65
80 x 65	2,0	1	IARC60A9	15,05
100 x 50	2,0	1	IARC60C8	25,70
100 x 65	2,0	1	IARC60C9	23,05
100 x 80	2,0	1	IARC60CA	21,25

VÁLVULAS – INDÚSTRIA ALIMENTAR

VÁLVULA DE BORBOLETA PARA ALIMENTAR DIN 11851 – ROSCAR / ROSCAR

Produzida em aço inoxidável AISI 304.
Elastômetro em EPDM.
Extremos roscados conforme DIN 11851.
Pressão máxima de serviço: PN 10.
Temperatura de serviço: - 20° C a 130° C.

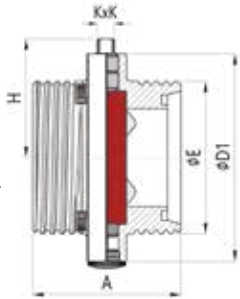

Ø	H	Ø E	KxK	A	Ø D1		COD.	€
25	50,5	RD52x1/6"	8 x 8	66	78	16 1	IV90E025	61,45
32	54,5	RD58x1/6"	8 x 8	70	86	16 1	IV90E032	66,90
40	56,0	RD65x1/6"	8 x 8	74	95	16 1	IV90E040	75,35
50	64,0	RD78x1/6"	8 x 8	76	108	8 1	IV90E050	93,80
65	74,0	RD95x1/6"	8 x 8	84	125	8 1	IV90E065	126,40
80	81,5	RD110x1/4"	10 x 10	90	140	6 1	IV90E080	164,65
100	91,5	RD130x1/4"	10 x 10	104	160	4 1	IV90E100	271,00

VÁLVULA DE BORBOLETA PARA ALIMENTAR DIN 11851 – ROSCAR / SOLDAR

Produzida em aço inoxidável AISI 304.
Elastômetro em EPDM.
Extremo roscado conforme DIN 11851 / soldar.
Pressão máxima de serviço: PN 10.
Temperatura de serviço: - 20° C a 130° C.

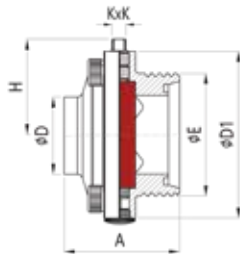

Ø	H	Ø D	Ø E	KxK	A	Ø D1		COD.	€
25	50,5	28	RD52x1/6"	8 x 8	58	78	16 1	IV91E025	54,45
32	54,5	34	RD58x1/6"	8 x 8	58	86	16 1	IV91E032	61,55
40	56,0	40	RD65x1/6"	8 x 8	60	95	16 1	IV91E040	70,05
50	64,0	52	RD78x1/6"	8 x 8	64	108	12 1	IV91E050	85,35
65	74,0	70	RD95x1/6"	8 x 8	68	125	8 1	IV91E065	113,75
80	81,5	85	RD110x1/4"	10 x 10	71	140	8 1	IV91E080	150,30
100	91,5	104	RD130x1/4"	10 x 10	84	160	4 1	IV91E100	220,65

VÁLVULA DE BORBOLETA PARA ALIMENTAR DIN 11851 – SOLDAR / SOLDAR

Produzida em aço inoxidável AISI 304.
Elastômetro em EPDM.
Extremo soldar / soldar.
Pressão máxima de serviço: PN 10.
Temperatura de serviço: - 20° C a 130° C.

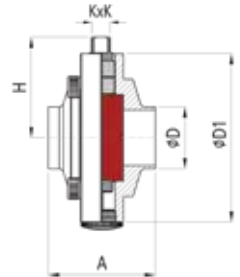

Ø	H	Ø D	KxK	A	Ø D1		COD.	€
25	50,5	28	8 x 8	50	78	16 1	IV92E025	45,35
32	54,5	34	8 x 8	50	86	16 1	IV92E032	61,30
40	56,0	40	8 x 8	50	95	16 1	IV92E040	65,20
50	64,0	52	8 x 8	52	108	12 1	IV92E050	74,20
65	74,0	70	8 x 8	56	125	8 1	IV92E065	95,10
80	81,5	85	10 x 10	60	140	8 1	IV92E080	131,55
100	91,5	104	10 x 10	64	160	4 1	IV92E100	163,55

MANIPULO PARA VÁLVULA DE BORBOLETA DIN 11851

Produzida em aço inoxidável AISI 304.
Acionamento manual em 3 posições.

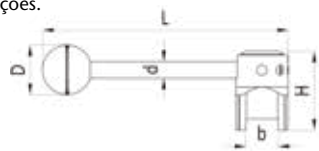

Ø	D	d	b	H	L		COD.	€
25-65	32	10,5	20,2	50	153	60 1	IV9P0025	21,80
80-100	40	12,0	22,1	56	203	40 1	IV9P0080	26,95

JUNTA PARA VÁLVULA DE BORBOLETA DIN 11851

Ø		COD. EPDM	€	COD. NBR	€
25	384 2	IV9GE025	4,90	IV9GN025	5,40
32	210 2	IV9GE032	5,40	IV9GN032	6,05
40	148 2	IV9GE040	6,05	IV9GN040	6,55
50	160 2	IV9GE050	7,10	IV9GN050	7,70
65	84 2	IV9GE065	8,10	IV9GN065	8,60
80	30 2	IV9GE080	10,80	IV9GN080	11,80
100	36 2	IV9GE100	15,05	IV9GN100	16,40

VÁLVULAS EM AÇO INOXIDÁVEL AISI 316



VÁLVULA DE ESFERA 1 CORPO

Corpo em aço inoxidável CF8M (AISI316).
Eixo em AISI 316.
Manípulo em AISI 304 revestido a PVC azul.
Assento da esfera PTFE +15% GF.
Extremos rosca ISO 7/1 (rosca R-Rp).
Temperatura de serviço: -20° C a 180° C.
Pressão de serviço: 1000 WOG/PN 63.
Sistema de bloqueio.

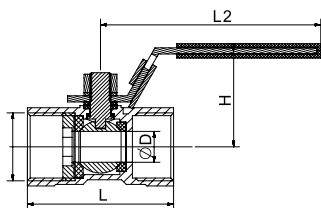

Ø	D mm.	L mm.	L2 mm.	H mm.		COD.	€
1/4"	5,0	40	62,5	30,7	200 1	IVB10061	9,70
3/8"	7,0	44	74,5	34,7	120 1	IVB10062	9,70
1/2"	9,2	56	86,5	40,7	70 1	IVB10063	11,15
3/4"	12,5	59	88,5	43,2	50 1	IVB10064	14,15
1"	15,0	71	107,0	49,2	30 1	IVB10065	19,00
1 1/4"	20,0	78	107,0	52,8	24 1	IVB10066	32,95
1 1/2"	25,0	83	132,0	66,4	16 1	IVB10067	36,35
2"	32,0	95	132,0	72,2	12 1	IVB10068	57,05



VÁLVULA DE ESFERA DOS PIEZAS PASO TOTAL

Corpo em aço inoxidável CF8M (AISI316).
Eixo em AISI 316.
Manípulo em AISI 304 revestido a PVC azul.
Assento da esfera PTFE +15% GF.
Extremos rosca ISO 7/1 (rosca R-Rp).
Temperatura de serviço: -20° C a 180° C.
Pressão de serviço: 1000 WOG/PN 63.
Sistema de bloqueio.

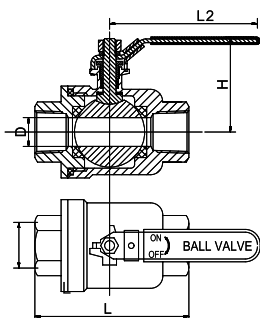

Ø	D mm.	L mm.	L2 mm.	H mm.		COD.	€
1/4"	11,5	49	105	44	60 1	IVB20061	13,40
3/8"	12,5	49	105	44	60 1	IVB20062	13,40
1/2"	15,0	56	100	46	45 1	IVB20063	13,55
3/4"	20,0	64	135	53	25 1	IVB20064	18,25
1"	25,0	75	135	57	16 1	IVB20065	27,05
1 1/4"	32,0	86	170	71	10 1	IVB20066	40,20
1 1/2"	38,0	96	170	75	6 1	IVB20067	55,05
2"	50,0	116	190	96	4 1	IVB20068	89,80
2 1/2"	65,0	150	250	128	4 1	IVB20069	211,35
3"	76,0	168	250	135	2 1	IVB2006A	306,30
4"	94,0	214	335	160	2 1	IVB2006C	580,15



VÁLVULA DE ESFERA TRÊS CORPOS PASSAGEM TOTAL – ROSCADA

Corpo em aço inoxidável CF8M (AISI 316).
Eixo em AISI 316.
Manípulo em AISI 304 revestido a PVC azul.
Assento da esfera em PTFE +15% GF.
Extremos roscados ISO 7/1 (Rosca R-RP).
Temperatura de serviço: -20° C a 180° C.
Pressão de serviço: 1000 WOG/PN 63.
Sistema de bloqueio.

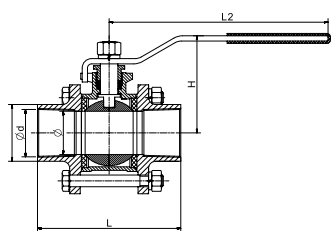

Ø	d mm.	L mm.	L2 mm.	H mm.		COD.	€
1/4"	12,50	51	100	45	40 1	IVB30061	22,30
3/8"	12,50	51	100	45	36 1	IVB30062	22,30
1/2"	15,00	62	100	49	30 1	IVB30063	22,30
3/4"	20,00	69	112	60	16 1	IVB30064	35,45
1"	25,00	79	112	64	11 1	IVB30065	40,20
1 1/4"	32,00	96	145	80	6 1	IVB30066	63,75
1 1/2"	38,00	102	145	83	4 1	IVB30067	80,40
2"	50,00	124	165	97	2 1	IVB30068	130,05
2 1/2"	65,00	159	230	118	2 1	IVB30069	258,10
3"	76,00	179	230	125	1 1	IVB3006A	373,05
4"	94,00	220	300	169	1 1	IVB3006C	678,55



FILTRO EM "Y"

Corpo em aço inoxidável CF8M (AISI 316).
Temperatura de serviço: -20° C a 160° C.
Extremos rosca ISO 7/1 (rosca R-Rp).
Pressão de serviço: PN 50.
Junta em PTFE.

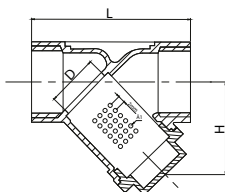

Ø	D mm.	L mm.	H mm.		COD.	€
1/2"	10	63	38	70 1	IVF00063	14,85
3/4"	20	80	55	45 1	IVF00064	19,00
1"	25	90	56	25 1	IVF00065	32,70
1 1/4"	32	108	60	14 1	IVF00066	43,05
1 1/2"	40	120	70	12 1	IVF00067	54,55
2"	50	142	82	6 1	IVF00068	82,45



TORNEIRA DE JARDIM INOX

Corpo em aço inoxidável CF8M (AISI 316).
Eixo em AISI 316.
Manípulo em SS 301 revestido a PVC azul.
O- Ring em viton.
Extremos rosca BSP.
Temperatura de serviço: -20° C a 160° C.
Pressão de serviço: PN16.

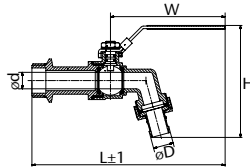

Ø	D mm.	L mm.	H mm.	W mm.		COD.	€
1/2"	13,0	145,0	87	92	40 1	IVG06003	21,40
3/4"	16,0	154,0	92	105	30 1	IVG06004	28,25
1"	27,5	183,5	115	105	20 1	IVG06005	32,55



VÁLVULA ESFERA MINI F/F

Corpo em aço inoxidável CF8M (AISI 316).
Manípulo em alumínio.
Esfera em aço inoxidável CF8M.
O-ring em viton.
Extremos rosca ISO 7/1 (rosca R-Rp).

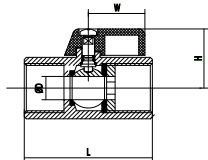

Ø	D mm.	L mm.	H mm.	W mm.		COD.	€
1/4"	7,0	42	25,0	22,8	160 1	IVBHH061	14,00
3/8"	7,0	42	25,0	22,8	160 1	IVBHH062	14,00
1/2"	9,2	47	28,3	22,8	80 1	IVBHH063	17,75



VÁLVULA ESFERA MINI M/F

Corpo em aço inoxidável CF8M (AISI 316).
Manípulo em alumínio.
Esfera em aço inoxidável CF8M.
O-ring em viton.
Extremos rosca ISO 7/1 (rosca R-Rp).

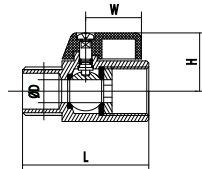

Ø	D mm.	L mm.	H mm.	W mm.		COD.	€
1/4"	7,0	42	25,0	22,8	160 1	IVBMH061	14,00
3/8"	7,0	42	25,0	22,8	160 1	IVBMH062	14,00
1/2"	9,2	47	28,3	22,8	80 1	IVBMH063	17,75



VÁLVULA DE RETENÇÃO DE CHARNEIRA – SÉRIE LIGEIRA

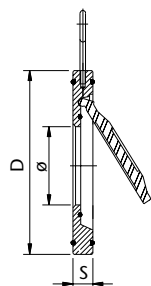

DN	S mm.	D mm.	Ø mm.	PESO Kg.	COD.	€
40	14	94	22	0,8	VF540040	69,55
50	14	107	32	1,0	VF540050	73,15
65	14	127	40	1,5	VF540065	90,05
80	14	142	54	2,0	VF540080	116,65
100	18	162	70	2,5	VF540100	165,25
125	18	192	92	3,5	VF540125	212,25
150	20	218	114	4,5	VF540150	277,45
200	22	273	154	7,5	VF540200	515,90
250	26	329	200	12,0	VF540250	772,05
300	28	384	235	17,5	VF540300	1.057,75

CARACTERÍSTICAS TÉCNICAS

Pressão de serviço: PN 16.
Temperatura de serviço: -10° C a 150° C .
Para flanges DIN EN 1092-2 PN16.

COMPONENTES

Corpo: Aço Inoxidável AISI 316
Disco: Aço Inoxidável AISI 316
Assento da charneira: Viton
Assento da flange: Viton
Fixação: Aço Inoxidável AISI 316



VÁLVULA DE ESFERA 2 CORPOS PASSAGEM TOTAL COM PLACA – ROSCADA

Corpo em aço inoxidável CF8M (AISI316).
Eixo em AISI 316.
Manípulo em AISI 304 revestido a PVC azul.
Assento da esfera PTFE +15% GF.
Extremos rosca ISO 7/1 (rosca R-Rp).
Temperatura de serviço: -10° C a 150° C.
Pressão de serviço: 1000 WOG/PN 63.
Sistema de bloqueio.
Montagem de atuador direto conforme ISO 5211.

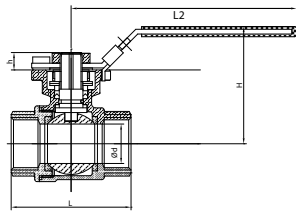

Ø	d mm.	L mm.	L2 mm.	H mm.	h mm.		COD.	€
1/4"	9,0	48,0	120,5	37,0	9	60 1	IVB2P061	19,60
3/8"	12,5	48,0	120,5	39,0	9	60 1	IVB2P062	19,60
1/2"	15,0	56,0	120,5	39,0	9	45 1	IVB2P063	22,20
3/4"	20,0	64,0	120,5	41,5	9	25 1	IVB2P064	31,70
1"	25,0	76,0	140,0	47,0	11	16 1	IVB2P065	42,00
1 1/4"	32,0	86,5	140,0	52,0	11	10 1	IVB2P066	62,10
1 1/2"	38,0	97,5	170,0	62,0	14	6 1	IVB2P067	79,35
2"	50,0	117,5	170,0	71,0	14	4 1	IVB2P068	122,80



VÁLVULA DE ESFERA TRÊS CORPOS PASSAGEM TOTAL COM PLACA – ROSCADA

Corpo em aço inoxidável CF8M (AISI 316).
Eixo em AISI 316.
Manípulo em AISI 304 revestido a PVC azul.
Assento da esfera PTFE +15% GF.
Extremos rosca ISO 7/1 (Rosca R-RP).
Temperatura de serviço: -20° C a 180° C.
Pressão de serviço: 1000 WOG/PN 63.
Sistema de bloqueio.
Montagem de atuador direto conforme ISO 5211.

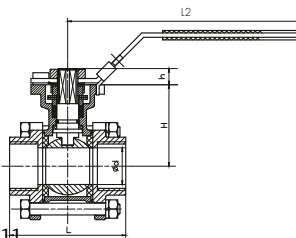

Ø	d mm.	L mm.	L2 mm.	H mm.	h mm.		COD.	€
1/2"	15	61	120,5	39,0	9	30 1	IVB3P063	30,55
3/4"	20	69	120,5	41,5	9	16 1	IVB3P064	41,75
1"	25	79	140,0	47,0	11	11 1	IVB3P065	50,30
1 1/4"	32	96	140,0	52,0	11	6 1	IVB3P066	83,40
1 1/2"	38	102	170,0	62,0	14	4 1	IVB3P067	107,10
2"	50	124	170,0	71,0	14	2 1	IVB3P068	154,15
2 1/2"	65	158	230,0	89,0	18	2 1	IVB3P069	375,90
3"	76	179	230,0	98,0	18	1 1	IVB3P06A	538,20
4"	94	220	300,0	129,0	22	1 1	IVB3P06C	815,20



VÁLVULA DE ESFERA TRÊS CORPOS PASSAGEM TOTAL COM PLACA – BUTT WELD

Corpo em aço inoxidável CF8M (AISI 316).
Eixo em AISI 316.
Manípulo em AISI 304 revestido a PVC azul.
Assento da esfera em PTFE +15% GF.
Temperatura de serviço: -20° C a 180° C.
Pressão de serviço: 1000 WOG/PN 63.
Sistema de bloqueio.
Montagem de atuador direto conforme ISO 5211.
Extremos para soldar Butt Weld ANSI B 16.25.

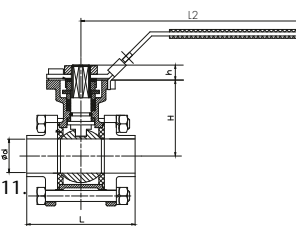

Ø	d mm.	L mm.	L2 mm.	H mm.	h mm.		COD.	€
1/2"	15	61	120,5	39,0	9	30 1	IVB3PB63	30,55
3/4"	20	69	120,5	41,5	9	16 1	IVB3PB64	41,75
1"	25	79	140,0	47,0	11	11 1	IVB3PB65	50,30
1 1/4"	32	96	140,0	52,0	11	6 1	IVB3PB66	83,40
1 1/2"	38	102	170,0	62,0	14	4 1	IVB3PB67	107,10
2"	50	124	170,0	71,0	14	2 1	IVB3PB68	154,15
2 1/2"	65	158	230,0	89,0	18	2 1	IVB3PB69	375,90
3"	76	179	230,0	98,0	18	1 1	IVB3PB6A	538,20
4"	94	220	300,0	129,0	22	1 1	IVB3PB6C	815,20



VÁLVULA DE ESFERA TRÊS CORPOS PASSAGEM TOTAL COM PLACA – SOCKET WELD

Corpo em aço inoxidável CF8M (AISI 316).
Eixo em AISI 316.
Manípulo em AISI 304 revestido a PVC azul.
Assento da esfera em PTFE +15% GF.
Temperatura de serviço: -20° C a 180° C.
Pressão de serviço: 1000 WOG/PN 63.
Sistema de bloqueio.
Montagem de atuador direto conforme ISO 5211.
Extremos para soldar Socket Weld ANSI B 16.11.

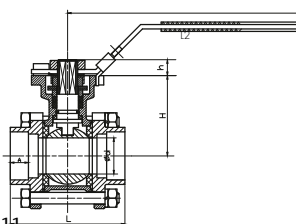

Ø	d mm.	L mm.	L2 mm.	H mm.	h mm.		COD.	€
1/2"	15	61	120,5	39,0	9	30 1	IVB3PS63	30,55
3/4"	20	69	120,5	41,5	9	16 1	IVB3PS64	41,75
1"	25	79	140,0	47,0	11	11 1	IVB3PS65	50,30
1 1/4"	32	96	140,0	52,0	11	6 1	IVB3PS66	83,40
1 1/2"	38	102	170,0	62,0	14	4 1	IVB3PS67	107,10
2"	50	124	170,0	71,0	14	2 1	IVB3PS68	154,15
2 1/2"	65	158	230,0	89,0	18	2 1	IVB3PS69	375,90
3"	76	179	230,0	98,0	18	1 1	IVB3PS6A	538,20
4"	94	220	300,0	129,0	22	1 1	IVB3PS6C	815,20

VÁLVULA DE ESFERA 3 VIAS PASSAGEM EM "T" OU "L"



Ø	DN	L1 ±2 mm.	Ø D mm.	H mm.	W mm.	ISO 5211		COD. TIPO "T"	COD. TIPO "L"	€
1/4"	8	64	9,0	76	143	F04/03	15 1	IVBT0061	IVBL0061	68,70
3/8"	10	64	11,0	76	143	F04/03	15 1	IVBT0062	IVBL0062	68,70
1/2"	15	64	12,5	76	143	F04/03	13 1	IVBT0063	IVBL0063	69,90
3/4"	20	68	16,0	80	143	F04/03	7 1	IVBT0064	IVBL0064	83,50
1"	25	82	20,0	95	163	F05/04	5 1	IVBT0065	IVBL0065	117,55
1 1/4"	32	90	25,0	98	163	F05/04	4 1	IVBT0066	IVBL0066	180,75
1 1/2"	40	107	32,0	110	188	F07/05	3 1	IVBT0067	IVBL0067	249,45
2"	50	124	38,0	119	188	F07/05	2 1	IVBT0068	IVBL0068	392,20

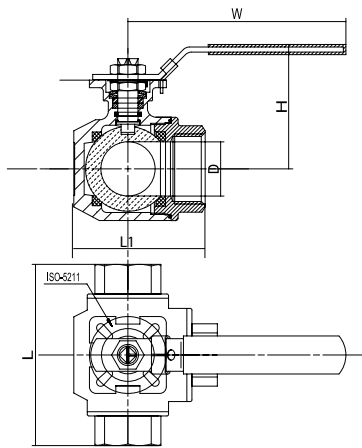

CARACTERÍSTICAS TÉCNICAS

Pressão de serviço: PN 63.
 Temperatura de serviço: -20° C a 180° C.
 Montagem de atuador direto conforme ISO 5211.
 Extremos rosca ISO 7/1 (rosca R-Rp).

COMPONENTES

Corpo: Aço inoxidável CF8M (AISI 316)
 Junta: PTFE+15% GF
 Junta do eixo: Viton
 Eixo: AISI 316
 Manípulo: AISI 304 revestido a PVC azul
 Bola: AISI 316

VÁLVULA DE ESFERA 2 CORPOS PASSAGEM TOTAL FLANGEADA



Ø	DN	L mm.	Ø d mm.	Ø D mm.	H mm.	W mm.	ISO 5211		COD.	€
1/2"	15	115	15	95	76	110	F03-F04	1	IVB20015	130,50
3/4"	20	120	20	105	81	110	F03-F04	1	IVB20020	166,70
1"	25	125	25	115	90	140	F04-F05	1	IVB20025	201,60
1 1/4"	32	130	32	140	102	140	F04-F05	1	IVB20032	288,55
1 1/2"	40	140	38	150	114	185	F05-F07	1	IVB20040	329,60
2"	50	150	50	165	122	185	F05-F07	1	IVB20050	434,00
2 1/2"	65	170	65	185	168	305	F07-F10	1	IVB20B65	627,55
3"	80	180	78	200	178	305	F07-F10	1	IVB20080	994,65
4"	100	190	100	220	198	305	F07-F10	1	IVB20100	1.457,50
5"	125	325	125	250	234	500	F10-F12	1	IVB20125	2.312,80
6"	150	350	150	285	250	645	F10-F12	1	IVB20150	3.233,05

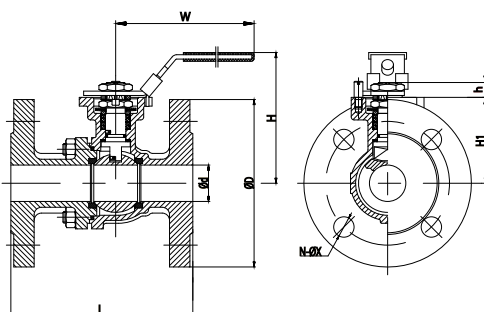

CARACTERÍSTICAS TÉCNICAS

Pressão de serviço: PN 40 de DN15 a DN40; PN 16 de DN50 a DN150.
 Temperatura de serviço: -30° C a 180° C.
 Flanges DIN 2635 de DN15 a DN40; DIN 2633 de DN50 a DN150.
 Distância entre faces conforme DIN 3202-F4.
 Fire Safe API607.
 Dispositivo anti estático.
 Montagem de atuador direto conforme ISO 5211
 Certificado ATEX segundo a directiva 2014/34/EU.

COMPONENTES

Corpo: Aço inoxidável CF8M (AISI 316)
 Junta: PTFE+15%GF
 Junta do eixo: Viton
 Eixo: AISI 316
 Manípulo: A276 201 revestido a PVC azul.
 Bola: AISI 316

VÁLVULA DE RETENÇÃO ROSCADA PN 63

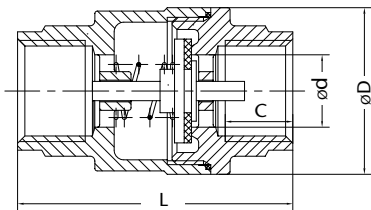

Ø	Ø d mm.	Ø D mm.	C mm.	L mm.	COD.	€
1/4"	10,5	30,0	12	54	IV130601	17,75
3/8"	13,0	30,0	12	54	IV130602	17,75
1/2"	15,0	34,5	14	57	IV130603	18,00
3/4"	20,0	41,5	15	64	IV130604	24,40
1"	25,0	48,6	18	80	IV130605	31,70
1 1/4"	32,0	60,5	17	82	IV130606	46,75
1 1/2"	40,0	71,0	18	93	IV130607	59,60
2"	50,0	87,0	17	100	IV130608	84,80

CARACTERÍSTICAS TÉCNICAS

Pressão de serviço: PN 63.

Extremos roscados conforme ISO 7/1.

Temperatura de serviço: -30° C a 150° C.

Instalação em qualquer posição desde que respeitando o sentido do fluido indicado pela seta.

COMPONENTES

Corpo: CF8M (AISI 316)

Mola: AISI 316

Disco: CF8M (AISI 316)

Vedante do disco: Viton

Tampão: CF8M (AISI 316)

Vedante: PTFE

VÁLVULA RETENÇÃO DE DISCO TIPO WAFER PN 63

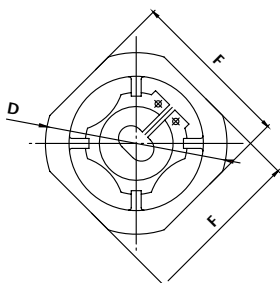
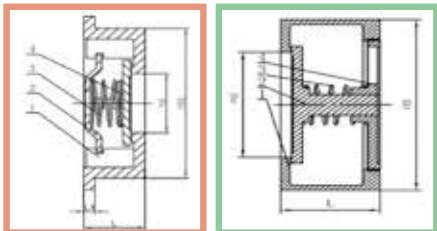

Ø	DN	Ø D mm.	F mm.	Ø D1 mm.	L1	L mm.	COD.	€
1/2"	15	53	46	43	4	16,5	IV566015	13,60
3/4"	20	63	55	53	5	19,5	IV566020	15,60
1"	25	73	65	63	4	22,0	IV566025	19,85
1 1/4"	32	84	78	75	6	28,0	IV566032	31,00
1 1/2"	40	94	88	86	6	32,0	IV566040	43,30
2"	50	107	98	94	7	40,0	IV566050	59,10
2 1/2"	65	126	118	115	7	46,0	IV566065	88,20
3"	80	144	134	130	8	50,0	IV566080	127,10
4"	100	164	154	152	9	60,0	IV566100	190,85
5"	125	190				82,0	IV566125	381,75
6"	150	217				102,0	IV566150	536,05

CARACTERÍSTICAS TÉCNICAS

Pressão de serviço: PN 63.

Temperatura de serviço: -20° C a 425° C.

Aplicações: Indústria química, alimentar, térmica e farmacêutica.

Aptas para: Água, gás, vapor, condensados, óleos e ácidos.

Instalação em qualquer posição desde que respeitando o sentido do fluido indicado pela seta.

Distância entre faces conforme EN 558 série 49 (salvo DN125 e 150).

COMPONENTES

Corpo: CF8M (AISI 316)

Suporte da mola: AISI 304

Mola: AISI 304

Disco: CF8M (AISI 316)

ACESSÓRIOS PARA SOLDAR - MILIMÉTRICO

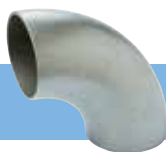

CURVA 90° 3D DE TUBO SOLDADO

Ø	Ø mm.	DN	R mm.	ESP. mm.	AISI 304L		AISI 316L	
					COD.	€	COD.	€
1/2"	18,0	15	25,0	1,5	IC341018	3,55	IC361018	4,15
1/2"	20,0	15	30,0	1,5	IC341020	3,90	IC361020	4,30
3/4"	23,0	20	35,0	1,5	IC341023	3,90		
3/4"	25,0	20	37,0	1,5	IC341025	3,95	IC361025	6,20
3/4"	28,0	20	40,0	1,5	IC341028	4,20	IC361028	6,45
3/4"	30,0	20	45,0	1,5	IC341030	4,50	IC361030	6,55
1"	33,0	25	50,0	1,5	IC341033	4,55	IC361033	6,70
1 1/4"	35,0	32	52,5	1,5	IC341035	4,75		
1 1/4"	38,0	32	55,0	1,5	IC341038	5,00		
1 1/2"	40,0	40	60,0	1,5	IC341040	5,65	IC361040	8,70
1 1/2"	43,0	40	65,0	1,5	IC341043	5,80	IC361043	8,75
2"	50,8	50	76,0	1,5	IC341051	7,00	IC361050	11,70
2"	53,0	50	80,0	1,5	IC341053	7,60	IC361053	12,35
2"	63,5	50	95,0	1,5	IC341063	13,00	IC361063	16,05
2"	54,0	50	80,0	2,0	IC342054	9,55		
2"	57,0	50	85,5	2,0	IC342057	11,15		
2 1/2"	70,0	65	92,0	2,0	IC342070	13,70	IC362070	22,30
2 1/2"	73,0	65	110,0	1,5	IC341073	17,70	IC361073	26,25
2 1/2"	76,0	65	115,0	1,5	IC341076	17,70	IC361076	26,45
3"	84,0	80	125,0	2,0	IC342084	20,50	IC362084	36,05
4"	104,0	100	155,0	2,0	IC342104	29,50	IC362104	44,95
5"	129,0	125	190,0	2,0	IC342129	56,10	IC362129	87,05
6"	154,0	150	225,0	2,0	IC342154	87,00	IC362154	95,35
8"	204,0	200	300,0	2,0	IC342204	133,35	IC362204	189,10
10"	254,0	250	380,0	2,0	IC342254	305,05		



TÊ

Ø mm.	DN	ESP. mm.	AISI 304L		AISI 316L	
			COD.	€	COD.	€
25,0	20	1,5	ITM41025	12,15	ITM61025	14,00
28,0	20	1,5	ITM41028	12,15	ITM61028	14,25
33,0	25	1,5	ITM41033	13,55	ITM61033	16,10
43,0	40	1,5	ITM41043	16,75	ITM61043	19,25
50,8	50	1,5	ITM41050	18,40	ITM61050	21,05
53,0	50	1,5	ITM41053	18,70	ITM61053	23,75
63,5	50	1,5	ITM41063	30,55	ITM61063	34,60
73,0	65	1,5	ITM41073	38,00	ITM61073	43,05
84,0	80	2,0	ITM42084	38,40	ITM62084	53,10
104,0	100	2,0	ITM42104	55,95	ITM62104	75,60
129,0	125	2,0	ITM42129	113,00	ITM62129	135,35
154,0	150	2,0	ITM42154	153,70	ITM62154	189,90
204,0	200	2,0	ITM42204	280,45	ITM62204	331,80
254,0	250	2,0	ITM42254	516,00	ITM62254	653,50
304,0	300	2,0			ITM62304	984,40
354,0	300	2,0			ITM62354	1.374,80



TAMPÃO

Ø mm.	DN	ESP. mm.	AISI 304L		AISI 316L	
			COD.	€	COD.	€
25,0	20	1,5	ICAM4025	2,25	ICAM6025	3,10
28,0	20	1,5	ICAM4028	2,35	ICAM6028	3,30
33,0	25	1,5	ICAM4033	2,55	ICAM6033	3,45
43,0	40	1,5	ICAM4043	3,25	ICAM6043	4,75
50,8	50	1,5	ICAM4050	4,00	ICAM6050	5,80
53,0	50	1,5	ICAM4053	4,05	ICAM6053	5,90
63,5	50	1,5	ICAM4063	5,20	ICAM6063	7,60
70,0	65	2,0	ICAM4070	5,50	ICAM6070	7,80
73,0	65	1,5	ICAM4073	5,80	ICAM6073	8,75
84,0	80	2,0	ICAM4084	6,95	ICAM6084	9,55
104,0	100	2,0	ICAM4104	10,10	ICAM6104	11,95
129,0	125	2,0	ICAM4129	12,75	ICAM6129	17,20
154,0	150	2,0	ICAM4154	20,10	ICAM6154	24,10
204,0	200	2,0	ICAM4204	32,25	ICAM6204	41,20
254,0	250	2,0	ICAM4254	48,15	ICAM6254	65,75
304,0	300	2,0	ICAM4304	64,80	ICAM6304	82,50
354,0	300	2,0	ICAM4354	112,45	ICAM6354	145,60



ADAPTADOR PARA FLANGE VALONA

Ø	DN	ESP. mm.	AISI 304L		AISI 316L	
			COD.	€	COD.	€
25,0	20	1,5	ICM41025	1,65	ICM61025	2,15
28,0	20	1,5	ICM41028	1,90	ICM61028	2,70
33,0	25	1,5	ICM41033	2,15	ICM61033	3,10
43,0	40	1,5	ICM41043	2,95	ICM61043	4,30
50,8	50	1,5	ICM41050	4,00	ICM61050	5,35
53,0	50	1,5	ICM41053	4,05	ICM61053	5,35
63,5	50	1,5	ICM41063	4,50	ICM61063	6,55
70,0	65	2,0	ICM42070	5,10	ICM62070	7,10
73,0	65	1,5	ICM41073	5,25	ICM61073	7,55
84,0	80	2,0	ICM42084	6,40	ICM62084	9,00
104,0	100	2,0	ICM42104	8,10	ICM62104	11,95
129,0	125	2,0	ICM42129	10,75	ICM62129	14,05
154,0	150	2,0	ICM42154	12,00	ICM62154	17,00
204,0	200	2,0	ICM42204	18,80	ICM62204	26,95
254,0	250	2,0	ICM42254	25,65	ICM62254	33,75
304,0	300	2,0	ICM42304	30,55	ICM62304	41,75
354,0	300	2,0	ICM42354	42,20	ICM62354	58,00



REDUÇÃO CONCÊNTRICA

Ø mm.	DN	ESP. mm.	AISI 304L		AISI 316L	
			COD.	€	COD.	€
53,0 x 43,0	50 x 40	1,5	IRM45343	10,70	IRM65343	19,65
63,5 x 43,0	50 x 40	1,5	IRM46343	15,80	IRM66343	16,80
63,5 x 53,0	50 x 50	1,5	IRM46353	13,75	IRM66353	14,55
73,0 x 43,0	65 x 40	2,0	IRM47343	17,70	IRM67343	28,05
73,0 x 53,0	65 x 50	2,0	IRM47353	17,00	IRM67353	24,10
73,0 x 63,5	65 x 50	2,0	IRM47363	17,05	IRM67363	21,00
84,0 x 43,0	80 x 40	2,0	IRM48443	30,75	IRM68443	26,60
84,0 x 53,0	80 x 50	2,0	IRM48453	18,80	IRM68453	24,60
84,0 x 63,5	80 x 50	2,0	IRM48463	18,55	IRM68463	22,40
84,0 x 73,0	80 x 65	2,0	IRM48473	18,55	IRM68473	19,65
104,0 x 43,0	100 x 40	2,0	IRM41043	60,55	IRM61043	47,55
104,0 x 53,0	100 x 50	2,0	IRM41053	33,40	IRM61053	38,60
104,0 x 63,5	100 x 50	2,0	IRM41063	32,20	IRM61063	34,50
104,0 x 73,0	100 x 65	2,0	IRM41073	26,70	IRM61073	31,30
104,0 x 84,0	100 x 80	2,0	IRM41084	26,85	IRM61084	28,65
129,0 x 73,0	125 x 65	2,0	IRM41273	43,35	IRM61273	51,30
129,0 x 84,0	125 x 80	2,0	IRM41284	63,15	IRM61284	62,25
129,0 x 104,0	125 x 100	2,0	IRM41210	44,40	IRM61210	51,55
154,0 x 73,0	150 x 65	2,0	IRM41573	84,40	IRM61573	111,20
154,0 x 84,0	150 x 80	2,0	IRM41584	80,50	IRM61584	83,40
154,0 x 104,0	150 x 100	2,0	IRM41510	47,40	IRM61510	65,90
154,0 x 129,0	150 x 125	2,0	IRM41512	46,75	IRM61512	63,60
204,0 x 104,0	200 x 100	2,0	IRM42010	115,30	IRM62010	139,60
204,0 x 129,0	200 x 125	2,0	IRM42012	87,75	IRM62012	120,35
204,0 x 154,0	200 x 150	2,0	IRM42015	76,15	IRM62015	102,40

ACESSÓRIOS PARA SOLDAR - ISO

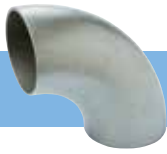

CURVA 90° 3D DE TUBO SOLDADO

Ø	Ø mm.	DN	AISI 304L ESP. 2 mm.		AISI 316L ESP. 2 mm.		AISI 316L ESP. 3 mm.	
			COD.	€	COD.	€	COD.	€
1/2"	21,3	15	IC934203	4,00	IC936203	4,30		
3/4"	26,9	20	IC934204	4,00	IC936204	4,30		
1"	33,7	25	IC934205	4,15	IC936205	5,30	IC936305	8,05
1 1/4"	42,4	32	IC934206	5,30	IC936206	6,55	IC936306	9,15
1 1/2"	48,3	40	IC934207	6,20	IC936207	7,80	IC936307	10,80
2"	60,3	50	IC934208	8,70	IC936208	11,30	IC936308	14,85
2 1/2"	76,1	65	IC934209	16,60	IC936209	20,15	IC936309	26,85
3"	88,9	80	IC93420A	19,00	IC93620A	28,25	IC93630A	34,50
4"	114,3	100	IC93420C	28,15	IC93620C	37,30	IC93630C	55,15
5"	139,7	125	IC93420D	64,15	IC93620D	89,50	IC93630D	115,55
6"	168,3	150	IC93420E	75,50	IC93620E	101,45	IC93630E	130,15
8"	219,1	200	IC93420F	133,35	IC93620F	171,85		
10"	273,0	250	IC93420G	289,90	IC93620G	393,10		
12"	323,9	300	IC93420H	426,20	IC93620H	693,15		

PARA AS RESTANTES MEDIDAS POR FAVOR CONSULTAR



TE

Ø	Ø mm.	DN	AISI 304L ESP. 2 mm.		AISI 316L ESP. 2 mm.	
			COD.	€	COD.	€
1/2"	21,3	15	IT104203	9,35	IT106203	11,20
3/4"	26,9	20	IT104204	10,00	IT106204	11,90
1"	33,7	25	IT104205	10,85	IT106205	12,75
1 1/4"	42,4	32	IT104206	12,40	IT106206	14,10
1 1/2"	48,3	40	IT104207	13,30	IT106207	15,35
2"	60,3	50	IT104208	21,65	IT106208	23,50
2 1/2"	76,1	65	IT104209	27,60	IT106209	30,50
3"	88,9	80	IT10420A	40,45	IT10620A	46,05
4"	114,3	100	IT10420C	82,45	IT10620C	57,55
5"	139,7	125	IT10420D	96,10	IT10620D	118,05
6"	168,3	150	IT10420E	125,55	IT10620E	149,30
8"	219,1	200	IT10420F	211,30	IT10620F	255,60
10"	273,0	250	IT10420G	417,05	IT10620G	534,20
12"	323,9	300	IT10420H	752,75	IT10620H	943,80

PARA AS RESTANTES MEDIDAS POR FAVOR CONSULTAR



TAMPÃO

Ø	Ø mm.	DN	AISI 304L ESP. 2 mm.		AISI 316L ESP. 2 mm.	
			COD.	€	COD.	€
1/2"	21,3	15	ICA04203	2,05	ICA06203	2,40
3/4"	26,9	20	ICA04204	2,10	ICA06204	2,55
1"	33,7	25	ICA04205	2,45	ICA06205	2,95
1 1/4"	42,4	32	ICA04206	3,25	ICA06206	4,15
1 1/2"	48,3	40	ICA04207	3,70	ICA06207	4,90
2"	60,3	50	ICA04208	4,40	ICA06208	7,40
2 1/2"	76,1	65	ICA04209	6,50	ICA06209	9,35
3"	88,9	80	ICA0420A	8,20	ICA0620A	12,15
4"	114,3	100	ICA0420C	11,65	ICA0620C	16,20
5"	139,7	125	ICA0420D	16,00	ICA0620D	24,05
6"	168,3	150	ICA0420E	22,50	ICA0620E	34,75
8"	219,1	200	ICA0420F	28,80	ICA0620F	43,65
10"	273,0	250	ICA0420G	37,60	ICA0620G	62,05
12"	323,9	300	ICA0420H	45,15	ICA0620H	74,45

PARA AS RESTANTES MEDIDAS POR FAVOR CONSULTAR

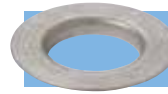

ADAPTADOR PARA FLANGE VALONA

Ø	Ø mm.	DN	AISI 304L ESP. 2 mm.		AISI 316L ESP. 2 mm.	
			COD.	€	COD.	€
1/2"	21,3	15	ICT04203	1,10	ICT06203	1,60
3/4"	26,9	20	ICT04204	1,60	ICT06204	1,95
1"	33,7	25	ICT04205	2,10	ICT06205	2,30
1 1/4"	42,4	32	ICT04206	2,70	ICT06206	4,05
1 1/2"	48,3	40	ICT04207	3,35	ICT06207	4,45
2"	60,3	50	ICT04208	4,15	ICT06208	6,15
2 1/2"	76,1	65	ICT04209	5,60	ICT06209	8,15
3"	88,9	80	ICT0420A	6,40	ICT0620A	8,55
4"	114,3	100	ICT0420C	8,15	ICT0620C	11,20
5"	139,7	125	ICT0420D	10,15	ICT0620D	14,95
6"	168,3	150	ICT0420E	11,65	ICT0620E	17,20
8"	219,1	200	ICT0420F	18,60	ICT0620F	28,05
10"	273,0	250	ICT0420G	19,05	ICT0620G	31,70
12"	323,9	300	ICT0420H	21,60	ICT0620H	32,50

PARA AS RESTANTES MEDIDAS POR FAVOR CONSULTAR



REDUÇÃO CONCÊNTRICA

Ø	Ø mm.	DN	ALTURA mm.	AISI 304L ESP. 2 mm.		AISI 316L ESP. 2 mm.	
				COD.	€	COD.	€
3/4" x 1/2"	26,9 x 21,3	20 x 15	38	IRC04243	4,50	IRC06243	5,60
1" x 1/2"	33,7 x 21,3	25 x 15	51	IRC04253	5,10	IRC06253	6,20
1" x 3/4"	33,7 x 26,9	25 x 20	51	IRC04254	4,50	IRC06254	6,55
1 1/4" x 1"	42,4 x 33,7	32 x 25	51	IRC04265	6,15	IRC06265	6,50
1 1/2" x 1/2"	48,3 x 21,3	40 x 15	64	IRC04273	13,95	IRC06273	18,05
1 1/2" x 1"	48,3 x 33,7	40 x 25	64	IRC04275	8,05	IRC06275	10,55
1 1/2" x 1 1/4"	48,3 x 42,4	40 x 32	64	IRC04276	7,00	IRC06276	8,60
2" x 1/2"	60,3 x 21,3	50 x 15	76	IRC04283	22,85	IRC06283	29,15
2" x 3/4"	60,3 x 26,9	50 x 20	76	IRC04284	19,25		
2" x 1"	60,3 x 33,7	50 x 25	76	IRC04285	10,95	IRC06285	12,60
2" x 1 1/4"	60,3 x 42,4	50 x 32	76	IRC04286	10,55	IRC06286	10,95
2" x 1 1/2"	60,3 x 48,3	50 x 40	76	IRC04287	10,15	IRC06287	10,40
2 1/2" x 1 1/2"	76,1 x 48,3	65 x 40	89	IRC04297	11,15	IRC06297	16,60
2 1/2" x 2"	76,1 x 60,3	65 x 50	89	IRC04298	10,70	IRC06298	13,00
3" x 1"	88,9 x 33,7	80 x 25	89	IRC042A5	24,30	IRC062A5	45,40
3" x 1 1/2"	88,9 x 48,3	80 x 40	89	IRC042A7	18,25	IRC062A7	21,00
3" x 2"	88,9 x 60,3	80 x 50	89	IRC042A8	17,70	IRC062A8	17,95
3" x 2 1/2"	88,9 x 76,1	80 x 65	89	IRC042A9	14,35	IRC062A9	20,35
4" x 1 1/2"	114,3 x 48,3	100 x 40	102	IRC042C7	19,80	IRC062C7	45,30
4" x 2"	114,3 x 60,3	100 x 50	102	IRC042C8	18,40	IRC062C8	23,20
4" x 2 1/2"	114,3 x 76,1	100 x 65	102	IRC042C9	17,00	IRC062C9	37,15
4" x 3"	114,3 x 88,9	100 x 80	102	IRC042CA	16,50	IRC062CA	18,65
5" x 3"	139,7 x 88,9	125 x 80	127	IRC042DA	33,35	IRC062DA	51,80
5" x 4"	139,7 x 114,3	125 x 100	127	IRC042DC	32,65	IRC062DC	40,75
6" x 4"	168,3 x 114,3	150 x 100	140	IRC042EC	44,85	IRC062EC	53,05
6" x 5"	168,3 x 139,7	150 x 125	140	IRC042ED	42,95		
8" x 3"	219,1 x 88,9	200 x 80	152			IRC062FA	155,15
8" x 4"	219,1 x 114,3	200 x 100	152	IRC042FC	88,60		
8" x 5"	219,1 x 139,7	200 x 125	152	IRC042FD	71,95	IRC062FD	110,30
8" x 6"	219,1 x 168,3	200 x 150	152	IRC042FE	64,00		
10" x 6"	273,0 x 168,3	250 x 150	178	IRC042GE	186,30		
10" x 8"	273,0 x 219,1	250 x 200	178	IRC042GF	150,25		
12" x 8"	323,9 x 219,1	300 x 200	203	IRC042HF	289,15		
12" x 10"	323,9 x 273,0	300 x 250	203	IRC042HG	194,40		

ACCESÓRIOS PARA SOLDAR - NORMA ASTM - SCH 10S FABRICADO TUBO SOLDADO



CURVA 90° RAIO LONGO

Ø	Ø EXT mm.	ESP.	AISI 304L		AISI 316L	
			COD.	€	COD.	€
1/2"	21,3	2,11	I1CL940M	3,90	I1CL960M	4,75
3/4"	26,7	2,11	I1CL940T	5,00	I1CL960T	6,20
1"	33,4	2,77	I1CL9401	5,40	I1CL9601	6,75
1 1/4"	42,2	2,77	I1CL941C	6,55	I1CL961C	8,05
1 1/2"	48,3	2,77	I1CL941M	9,30	I1CL961M	11,55
2"	60,3	2,77	I1CL9402	12,35	I1CL9602	15,60
2 1/2"	73,0	3,05	I1CL942M	17,50	I1CL962M	21,90
3"	88,9	3,05	I1CL9403	27,20	I1CL9603	35,35
4"	114,3	3,05	I1CL9404	47,05	I1CL9604	60,35
5"	141,3	3,40	I1CL9405	87,10	I1CL9605	112,05
6"	168,3	3,40	I1CL9406	120,80	I1CL9606	155,65
8"	219,1	3,76	I1CL9408	217,65	I1CL9608	276,30
10"	273,0	4,19	I1CL9410	469,50	I1CL9610	601,75



TÉ

Ø	Ø EXT mm.	ESP.	AISI 304L		AISI 316L	
			COD.	€	COD.	€
1/2"	21,3	2,11	I1T4000M	9,25	I1T6000M	12,40
3/4"	26,7	2,11	I1T4000T	9,75	I1T6000T	12,70
1"	33,4	2,77	I1T40001	10,30	I1T60001	12,90
1 1/4"	42,2	2,77	I1T4001C	14,05	I1T6001C	17,60
1 1/2"	48,3	2,77	I1T4001M	20,35	I1T6001M	25,30
2"	60,3	2,77	I1T40002	24,15	I1T60002	30,05
2 1/2"	73,0	3,05	I1T4002M	41,75	I1T6002M	51,60
3"	88,9	3,05	I1T40003	48,75	I1T60003	61,25
4"	114,3	3,05	I1T40004	78,95	I1T60004	98,00
5"	141,3	3,40	I1T40005	142,70	I1T60005	174,15
6"	168,3	3,40	I1T40006	176,80	I1T60006	219,20
8"	219,1	3,76	I1T40008	394,90	I1T60008	484,95



TAMPÃO

Ø	Ø EXT mm.	ESP.	AISI 304L		AISI 316L	
			COD.	€	COD.	€
1/2"	21,3	2,11	I1CC400M	4,45	I1CC600M	6,20
3/4"	26,7	2,11	I1CC400T	5,35	I1CC600T	7,45
1"	33,4	2,77	I1CC4001	6,65	I1CC6001	9,20
1 1/4"	42,2	2,77	I1CC401C	7,55	I1CC601C	10,60
1 1/2"	48,3	2,77	I1CC401M	8,45	I1CC601M	12,05
2"	60,3	2,77	I1CC4002	8,80	I1CC6002	12,50
2 1/2"	73,0	3,05	I1CC402M	11,85	I1CC602M	16,25
3"	88,9	3,05	I1CC4003	17,75	I1CC6003	24,40
4"	114,3	3,05	I1CC4004	25,95	I1CC6004	36,90
5"	141,3	3,40	I1CC4005	43,60	I1CC6005	61,20
6"	168,3	3,40	I1CC4006	54,50	I1CC6006	77,35
8"	219,1	3,76	I1CC4008	88,55	I1CC6008	129,45



COLARINHO

Ø	Ø EXT mm.	ESP.	AISI 304L		AISI 316L	
			COD.	€	COD.	€
1/2"	21,3	2,11	I1SE400M	9,70	I1SE600M	13,85
3/4"	26,7	2,11	I1SE400T	10,40	I1SE600T	14,85
1"	33,4	2,77	I1SE4001	12,55	I1SE6001	15,95
1 1/4"	42,2	2,77	I1SE401C	13,35	I1SE601C	18,15
1 1/2"	48,3	2,77	I1SE401M	14,55	I1SE601M	20,35
2"	60,3	2,77	I1SE4002	21,10	I1SE6002	29,40
2 1/2"	73,0	3,05	I1SE402M	23,40	I1SE602M	32,15
3"	88,9	3,05	I1SE4003	31,55	I1SE6003	43,45
4"	114,3	3,05	I1SE4004	47,15	I1SE6004	64,45
5"	141,3	3,40	I1SE4005	68,00	I1SE6005	94,85
6"	168,3	3,40	I1SE4006	104,75	I1SE6006	142,70
8"	219,1	3,76	I1SE4008	170,65	I1SE6008	242,20
10"	273,0	4,19	I1SE4010	337,65	I1SE6010	472,65



REDUÇÃO CONCÊNTRICA

Ø	Ø EXT mm.	AISI 304L		AISI 316L	
		COD.	€	COD.	€
3/4" x 1/2"	26,7 x 21,3	I1R40TOM	3,80	I1R60TOM	4,85
1" x 1/2"	33,4 x 21,3	I1R4010M	4,25	I1R6010M	5,40
1" x 3/4"	33,4 x 26,7	I1R4010T	3,90	I1R6010T	4,95
1 1/4" x 3/4"	42,2 x 26,7	I1R41C0T	6,75	I1R61C0T	8,75
1 1/4" x 1"	42,2 x 33,4	I1R41C01	6,10	I1R61C01	7,80
1 1/2" x 3/4"	48,3 x 26,7	I1R41M0T	8,30	I1R61M0T	10,50
1 1/2" x 1"	48,3 x 33,4	I1R41M01	7,45	I1R61M01	9,70
1 1/2" x 1 1/4"	48,3 x 42,2	I1R41M1C	7,40	I1R61M1C	9,35
2" x 1"	60,3 x 33,4	I1R40201	8,95	I1R60201	11,55
2" x 1 1/4"	60,3 x 42,2	I1R4021C	8,30	I1R6021C	10,50
2" x 1 1/2"	60,3 x 48,3	I1R4021M	8,00	I1R6021M	10,25
2 1/2" x 1 1/2"	73,0 x 48,3	I1R42M1M	16,75	I1R62M1M	21,20
2 1/2" x 2"	73,0 x 60,3	I1R42M02	16,15	I1R62M02	20,80
3" x 1 1/2"	88,9 x 48,3	I1R4031M	14,25	I1R6031M	18,80
3" x 2"	88,9 x 60,3	I1R40302	15,75	I1R60302	20,30
3" x 2 1/2"	88,9 x 73,0	I1R4032M	13,55	I1R6032M	18,00
4" x 2"	114,3 x 60,3	I1R40402	24,00	I1R60402	30,90
4" x 2 1/2"	114,3 x 73,0	I1R4042M	21,00	I1R6042M	27,90
4" x 3"	114,3 x 88,9	I1R40403	22,30	I1R60403	28,80
5" x 3"	141,3 x 88,9	I1R40503	54,85	I1R60503	69,35
5" x 4"	141,3 x 114,3	I1R40504	52,85	I1R60504	67,25
6" x 3"	168,3 x 88,9	I1R40603	74,85	I1R60603	97,00
6" x 4"	168,3 x 114,3	I1R40604	66,75	I1R60604	84,35
6" x 5"	168,3 x 141,3	I1R40605	63,90	I1R60605	80,20
8" x 6"	219,1 x 168,3	I1R40806	109,35	I1R60806	140,70

PARAFUSOS EM AÇO INOXIDÁVEL

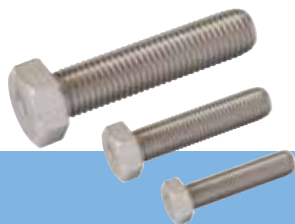

PARAFUSO HEXAGONAL
DIN 933 - INOX A2

MEDIDA	COMPRIM		COD.	€ 100 UNID.
M12	50	300 50	TI331250	63,00
M12	60	300 50	TI331260	72,45
M14	60	200 50	TI331460	110,25
M14	70	150 50	TI331470	126,00
M14	80	150 50	TI331480	131,25
M16	40	200 25	TI331640	110,25
M16	50	150 25	TI331650	126,00
M16	60	150 25	TI331660	141,75
M16	70	150 25	TI331670	157,50
M16	80	100 25	TI331680	173,25
M16	90	100 25	TI331690	189,00
M16	100	100 25	TI331610	210,00
M16	110	100 25	TI331611	225,75
M16	120	75 25	TI331612	241,50
M20	70	75 25	TI332070	267,75
M20	80	75 25	TI332080	294,00
M20	90	50 25	TI332090	315,00
M20	100	50 25	TI332010	346,50
M20	110	50 25	TI332011	372,75
M20	120	50 25	TI332012	399,00
M24	90	40 20	TI332490	546,00
M27	120	20 10	TI332712	966,00
M30	130	20 10	TI333013	1.333,50
M33	140	15 5	TI333314	1.701,00



PORCA HEXAGONAL
DIN 934 - INOX A2

MEDIDA		COD.	€ 100 UNID.
M6	7.200 150	TI934006	3,15
M8	3.750 125	TI934008	6,30
M10	1.600 100	TI934010	13,65
M12	1.200 100	TI934012	19,95
M14	800 50	TI934014	29,40
M16	600 50	TI934016	40,95
M18	400 25	TI934018	60,90
M20	300 25	TI934020	75,60
M24	160 10	TI934024	141,75
M27	100 10	TI934027	273,00
M30	80 10	TI934030	367,50
M33	50 5	TI934033	493,50

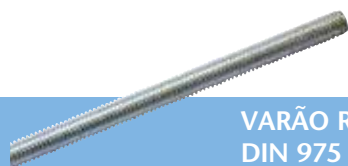

VARÃO ROSCADO 1.000 mm.
DIN 975 - INOX A2

MEDIDA		COD.	€ 100 UNID.
M6	50	TI975006	204,75
M8	25	TI975008	357,00
M10	25	TI975010	556,50
M12	20	TI975012	813,75
M14	15	TI975014	1.102,50
M16	10	TI975016	1.485,75
M18	5	TI975018	1.895,25
M20	5	TI975020	2.383,50



ANILHA PLANA
DIN 125 - INOX A2

MEDIDA		COD.	€ 100 UNID.
M6	7.200 150	TI125006	1,05
M8	6.000 125	TI125008	2,10
M10	4.800 100	TI125010	4,20
M12	3.000 100	TI125012	9,45
M14	2.100 70	TI125014	13,65
M16	1.680 70	TI125016	13,65
M18	1.200 50	TI125018	16,80
M20	1.200 50	TI125020	19,95
M24	600 50	TI125024	39,90
M27	400 50	TI125027	50,40
M30	300 50	TI125030	66,15
M33	240 30	TI125033	92,40



FLANGE PRENSADA

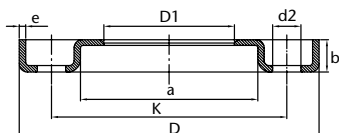

A montagem de flanges prensadas realiza-se com os respetivos adaptadores e juntas. Com os parafusos adequados obtêm-se uma perfeita estanquidade através da respetiva junta.

DN	Ø mm.	DIMENSÕES (mm.)								AISI 304L		AISI 316L	
		D1	D	K	a	e	b	d2	Nº Tal.	COD.	€	COD.	€
15	21,3	24	95	65	38	3	11,5	13,5	4	I4642015	9,15	I6642015	12,40
20	26,9	30	105	75	48	3	14,0	13,5	4	I4642020	10,45	I6642020	15,20
25	33,7	37	115	85	53	3	16,0	13,5	4	I4642025	13,10	I6642025	15,70
32	42,4	46	140	100	68	3	16,5	17,5	4	I4642032	16,40	I6642032	20,10
40	48,3	54	150	110	77	3	17,5	17,5	4	I4642040	18,10	I6642040	25,30
50	60,3	65	165	125	91	3	19,5	17,5	4	I4642050	20,15	I6642050	29,70
50	53,0	58	165	125	91	3	19,5	17,5	4	I4642053	19,15		
65	76,1	81	185	145	108	4	21,0	17,5	4	I4642065	25,30	I6642065	43,25
65	73,0	78	185	145	108	4	21,0	17,5	4	I4642073	25,25		
80	88,9	94	200	160	123	4	22,0	17,5	8	I4642080	33,55	I6642080	53,80
80	84,0	89	200	160	123	4	22,0	17,5	8	I4642084	32,40		
100	114,3	119	220	180	141	4	23,0	17,5	8	I4642100	38,45	I6642100	69,05
100	104,0	110	220	180	141	4	23,0	17,5	8	I4642104	34,60		
125	139,7	145	250	210	168	5	25,0	17,5	8	I4642125	64,30	I6642125	78,65
125	129,0	135	250	210	168	5	25,0	17,5	8	I4642129	59,30		
150	168,3	173	285	240	192	5	27,0	21,5	8	I4642150	72,50	I6642150	107,20
150	154,0	160	285	240	192	5	27,0	21,5	8	I4642154	66,70		
200	219,1	225	340	295	245	6	31,0	21,5	8	I4642200	116,95	I6642200	168,20
200	204,0	212	340	295	245	6	31,0	21,5	8	I4642204	116,75		
250	273,1	279	395	350	295	6	31,0	22,0	12	I4642250	177,45	I6642250	230,60
250	254,0	262	395	350	295	6	31,0	22,0	12	I4642254	147,00		
300	323,9	329	445	400	345	6	34,0	22,0	12	I4642300	199,80	I6642300	266,80

FLANGES ALUMÍNIO



FLANGE PLANA EM ALUMÍNIO ISO CONFORME DIN 2642

DN	Ø	D1	PN	DIMENSÕES (mm)			PARAFUSO		B1	COD.	€
				D	K	D5 (ISO)	NR	L			
40	1 1/2"	48,3	10	150	110	54	4	18	16	FPA10040	8,95
50	2"	60,3	10	165	125	65	4	18	16	FPA10050	9,95
65	2 1/2"	76,1	10	185	145	81	4	18	16	FPA10065	12,30
80	3"	88,9	10	200	160	94	8	18	18	FPA10080	14,85
100	4"	114,3	10	220	180	119	8	18	18	FPA10100	16,15
125	5"	139,7	10	250	210	145	8	18	18	FPA10125	19,95
150	6"	168,3	10	285	240	173	8	22	18	FPA10150	24,80
200	8"	219,1	10	340	295	225	8	22	20	FPA10200	35,00
250	10"	273,0	10	395	350	279	12	22	22	FPA10250	46,25
300	12"	323,9	10	445	400	329	12	22	22	FPA10300	59,55

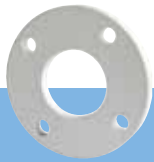
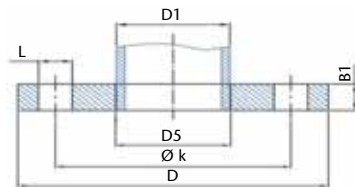

FLANGE PLANA EM ALUMÍNIO BRANCO DIN 2642

DN	Ø	D1	PN	NORMA	DIMENSÕES (mm)			PARAFUSO		B1	COD.	€
					D	K	D5 (ISO)	NR	L			
25	1"	33,7	10	ISO	115	85	36	4	M12	12	FPAB0025	5,75
32	1 1/4"	42,4	10	ISO	140	100	46	4	M16	16	FPAB0032	9,15
40	1 1/2"	43,0	10	MÉTRICO	150	110	48	4	M16	16	FPABM043	10,50
40	1 1/2"	48,3	10	ISO	150	110	54	4	M16	16	FPAB0040	12,50
50	2"	53,0	10	MÉTRICO	165	125	60	4	M16	16	FPABM053	14,70
50	2"	60,3	10	ISO	165	125	65	4	M16	16	FPAB0050	14,50
65	2 1/2"	73,0	10	MÉTRICO	185	145	75	4	M16	16	FPABM073	15,25
65	2 1/2"	76,1	10	ISO	185	145	81	4	M16	16	FPAB0065	16,45
80	3"	84,0	10	MÉTRICO	200	160	90	8	M16	18	FPABM084	16,90
80	3"	88,9	10	ISO	200	160	94	8	M16	18	FPAB0080	18,50
100	4"	104,0	10	MÉTRICO	220	180	111	8	M16	18	FPABM104	21,05
100	4"	114,3	10	ISO	220	180	119	8	M16	18	FPAB0100	18,95
125	5"	129,0	10	MÉTRICO	250	210	136	8	M16	18	FPABM129	23,40
125	5"	139,7	10	ISO	250	210	145	8	M16	18	FPAB0125	21,90
150	6"	154,0	10	MÉTRICO	285	240	161	8	M20	18	FPABM154	32,60
150	6"	168,3	10	ISO	285	240	173	8	M20	18	FPAB0150	26,85
200	8"	204,0	10	MÉTRICO	340	295	212	8	M20	20	FPABM204	48,40
200	8"	219,1	10	ISO	340	295	225	8	M20	20	FPAB0200	41,95
250	10"	254,0	10	MÉTRICO	395	350	264	12	M20	22	FPABM254	54,50
250	10"	273,0	10	ISO	395	350	279	12	M20	22	FPAB0250	48,50
300	12"	304,0	10	MÉTRICO	445	400	315	12	M20	22	FPABM304	58,60
300	12"	323,9	10	ISO	445	400	329	12	M20	22	FPAB0300	54,50

FLANGES EM AÇO INOXIDÁVEL FORJADAS

DIMENSÕES			FLANGE PLANA CONFORME NORMA EN 1092-1 01									
			AISI 304L									
			PN 10		PN 16				PN 25		PN 40	
DN	POLG.	mm.	COD.	€	COD.	€	COD. EN	€			COD.	€
15	1/2"	21,3	IF414015	14,75			IF414015	14,75	IF414015	14,75	IF414015	14,75
20	3/4"	26,9	IF414020	20,95			IF414020	20,95	IF414020	20,95	IF414020	20,95
25	1"	33,7	IF414025	25,85			IF414025	25,85	IF414025	25,85	IF414025	25,85
32	1 1/4"	42,4	IF414032	36,90			IF414032	36,90	IF414032	36,90	IF414032	36,90
40	1 1/2"	48,3	IF414040	39,20			IF414040	39,20	IF414040	39,20	IF414040	39,20
50	2"	60,3	IF416050	53,70			IF416050	53,70	IF416050	53,70	IF416050	53,70
65	2 1/2"	76,1	I4576065	65,25			I4576065	65,25				
65	2 1/2"	76,1	IF416065	65,25			IF416065	65,25	IF414065	71,70	IF414065	71,70
80	3"	88,9	IF416080	72,10			IF416080	72,10	IF414080	79,35	IF414080	79,35
100	4"	114,3	IF416100	76,25			IF416100	76,25	IF414100	83,80	IF414100	83,80
125	5"	139,7	IF416125	111,55			IF416125	111,55	IF414125	134,70	IF414125	134,70
150	6"	168,3	IF416150	145,10			IF416150	145,10	IF414150	169,40	IF414150	169,40
200	8"	219,1	IF411200	217,30			IF416200	220,05	IF412200	242,15	IF414200	294,30
250	10"	273,0	IF411250	251,95	I4502250*	241,35	IF416250	277,70	IF412250	330,50	IF414250	481,75
300	12"	323,9	IF411300	305,30	I4502300	386,70			IF412300	437,30	IF414300	741,55
350	14"	355,6	IF411350	666,10	I4502350	675,20						
400	16"	406,4	IF411400	701,75	I4502400	722,20						
450	18"	457,0	IF411450	916,25								
500	20"	508,0	IF411500	1.037,45	I4502500	1.148,00						
600	24"	610,0	IF411600	1.222,00	IF416600	2.060,75						
700	28"	711,0	IF411700	1.399,15	IF416700	2.086,35						
800	32"	813,0	IF411800	2.228,60	IF416800	2.228,60						

* Até fim de existências

Flanges não normalizadas
4 Furos
Conforme DIN 2502

DIMENSÕES			FLANGE CEGA CONFORME NORMA EN 1092-1 05					
			AISI 304L					
			PN 10		PN 16		PN 40	
DN	POLG.	mm.	COD.	€	COD.	€	COD.	€
15	1/2"	21,3	I4527015*	13,65	I4527015*	13,65		
	1/2"	21,3	IF454015	17,50	IF454015	17,50	IF454015	17,50
20	3/4"	26,9	I4527020*	19,80	I4527020*	19,80		
	3/4"	26,9	IF454020	25,45	IF454020	25,45	IF454020	25,45
25	1"	33,7						
	1"	33,7	IF454025	28,25	IF454025	28,25	IF454025	28,25
32	1 1/4"	42,4	IF454032	41,80	IF454032	41,80	IF454032	41,80
40	1 1/2"	48,3	IF454040	49,10	IF454040	49,10	IF454040	49,10
	1 1/2"	48,3						
50	2"	60,3	IF456050	59,05	IF456050	59,05	IF456050	59,05
65	2 1/2"	76,1	IF456065	82,10	IF456065	82,10		
80	3"	88,9	IF456080	92,40	IF456080	92,40		
100	4"	114,3	IF456100	108,90	IF456100	108,90		
125	5"	139,7	IF456125	156,70	IF456125	156,70		
150	6"	168,3	IF456150	207,25	IF456150	207,25		
200	8"	219,1	IF451200	322,65	IF456200	337,85		
250	10"	273,0	IF451250	528,60	IF456250	548,40		
300	12"	323,9	IF451300	645,70	IF456300	706,65		
350	14"	355,6	IF451350	745,40	IF456350	767,20		
400	16"	406,4	IF451400	1.089,85	IF456400	1.096,50		
500	20"	508,0	IF451500	1.615,55	IF456500	2.125,80		

* Até fim de existências

Conforme DIN 2527

FLANGE PLANA CONFORME NORMA EN 1092-1 01

AISI 316L										
PN 10			PN 16				PN 25		PN40	
COD. DIN	€	COD.	€	COD. EN	€	COD.	€	COD.	€	
IF614015	21,05			IF614015	21,05	IF614015	21,05	IF614015	21,05	
IF614020	25,80			IF614020	25,80	IF614020	25,80	IF614020	25,80	
IF614025	34,55			IF614025	34,55	IF614025	34,55	IF614025	34,55	
IF614032	52,00			IF614032	52,00	IF614032	52,00	IF614032	52,00	
IF614040	53,50			IF614040	53,50	IF614040	53,50	IF614040	53,50	
IF616050	69,50			IF616050	69,50	IF616050	69,50	IF616050	69,50	
I6576065	76,10			I6576065	76,10					
IF616065	76,10			IF616065	76,10	IF614065	83,65	IF614065	83,65	
IF616080	90,80			IF616080	90,80	IF614080	99,90	IF614080	99,90	
IF616100	104,30			IF616100	104,30	IF614100	136,40	IF614100	136,40	
IF616125	154,55			IF616125	154,55	IF614125	184,05	IF614125	184,05	
IF616150	175,75			IF616150	175,75	IF614150	231,50	IF614150	231,50	
IF611200	262,35	I6502200*	222,15	IF616200	262,35	IF612200	321,35	IF614200	402,25	
IF611250	335,30			IF616250	335,30	IF612250	451,70	IF614250	658,40	
IF611300	364,80	I6502300	490,00			IF612300	597,80	IF614300	1.013,45	
IF611350	674,25	I6502350	793,00							
IF611400	798,40	I6502400	874,30							
IF611450	1.019,90									
IF611500	1.277,15	I6502500	1.555,75							
IF611600	1.382,50	IF616600	1.841,85							
IF611700	2.047,30	IF616700	2.818,80							
IF611800	2.490,15	IF616800	2.864,50							

FLANGE CEGA CONFORME NORMA EN 1092-1 05

AISI 316L						
PN 10		PN 16		PN40		
COD.	€	COD.	€	COD.	€	€
IF654015	20,55	IF654015	20,55	IF654015		20,55
IF654020	28,25	IF654020	28,25	IF654020		28,25
IF654025	32,45	IF654025	32,45	IF654025		32,45
I6527032*	40,10	I6527032*	40,10			
IF654032	52,60	IF654032	52,60	IF654032		52,60
I6527040*	44,55	I6527040*	44,55			
IF654040	55,45	IF654040	55,45	IF654040		55,45
IF656050	73,10	IF656050	73,10	IF656050		73,10
IF656065	90,00	IF656065	90,00			
IF656080	110,90	IF656080	110,90			
IF656100	158,40	IF656100	158,40			
IF656125	212,65	IF656125	212,65			
IF656150	247,40	IF656150	247,40			
IF651200	443,25	IF656200	446,05			
IF651250	613,05	IF656250	621,15			
IF651300	825,90	IF656300	953,10			
IF651350	1.034,55	IF656350	1.258,30			
IF651400	1.268,10	IF656400	1.697,35			
IF651500	2.375,80	IF656500	3.370,70			

DIMENSÕES			FLANGE COM COLARINHO CONFORME NORMA EN 1092-1 11					
			AISI 304L					
			PN 10		PN 16		PN 40	
DN	POLG.	mm.	COD.	€	COD.	€	COD.	€
15	1/2"	21,3	I4633015*	11,70	I4633015*	11,70		
	1/2"	21,3	IF424015	15,70	IF424015	15,70	IF424015	15,70
20	3/4"	26,9	I4633020*	17,80	I4633020*	17,80		
	3/4"	26,9	IF424020	22,70	IF424020	22,70	IF424020	22,70
25	1"	33,7	I4633025*	20,00	I4633025*	20,00		
	1"	33,7	IF424025	26,00	IF424025	26,00	IF424025	26,00
32	1 1/4"	42,4	I4633032*	34,60	I4633032*	34,60		
	1 1/4"	42,4	IF424032	41,15	IF424032	41,15	IF424032	41,15
40	1 1/2"	48,3	I4633040*	41,00	I4633040*	41,00		
	1 1/2"	48,3	IF424040	46,65	IF424040	46,65	IF424040	46,65
50	2"	60,3	IF426050	54,95	IF426050	54,95	IF426050	54,95
65	2 1/2"	76,1	I4633065	73,30	I4633065	73,30		
	2 1/2"	76,1	IF426065	73,30	IF426065	73,30		
80	3"	88,9	IF426080	87,50	IF426080	87,50		
100	4"	114,3	IF426100	99,15	IF426100	99,15		
125	5"	139,7	IF426125	140,95	IF426125	140,95		
150	6"	168,3	IF426150	185,95	IF426150	185,95		
200	8"	219,1			IF426200	280,15		
250	10"	273,0			IF426250	372,90		
300	12"	323,9			IF426300	521,55		
350	14"	355,6			IF426350	729,35		
400	16"	406,4			IF426400	1.119,05		
500	20"	508,0			IF426500	1.538,70		

* Até fim de existências

4 Furos Conforme DIN 2633



DIMENSÕES			FLANGE PLANA MM CONFORME NORMA EN 1092-1 01 / DIN 2576											
			AISI 304L						AISI 316L					
			PN 10		PN 16		PN 40		PN 10		PN 16		PN 40	
DN	POLG.	mm.	COD.	€	COD.	€	COD.	€	COD.	€	COD.	€	COD.	€
15	1/2"	18	IM414015	17,20	IM414015	17,20	IM414015	17,20	IM614015	21,95	IM614015	21,95	IM614015	21,95
20	3/4"	23	IM414020	25,10	IM414020	25,10	IM414020	25,10	IM614020	28,20	IM614020	28,20	IM614020	28,20
25	1"	28	IM414025	26,95	IM414025	26,95	IM414025	26,95	IM614025	32,05	IM614025	32,05	IM614025	32,05
32	1 1/4"	38	IM414032	41,85	IM414032	41,85			IM614032	50,20	IM614032	50,20		
40	1 1/2"	43	IM414040	46,80	IM414040	46,80			IM614040	58,75	IM614040	58,75		
50	2"	53	IM416050	61,05	IM416050	61,05			IM616050	75,90	IM616050	75,90		
65	2 1/2"	73	IM416065	72,95	IM416065	72,95			IM616065	83,95	IM616065	83,95		
80	3"	84	IM416080	81,05	IM416080	81,05			IM616080	101,55	IM616080	101,55		
100	4"	104	IM416100	93,85	IM416100	93,85			IM616100	119,35	IM616100	119,35		
125	5"	129	IM416125	131,90	IM416125	131,90			IM616125	162,00	IM616125	162,00		
150	6"	154	IM416150	170,55	IM416150	170,55			IM616150	209,30	IM616150	209,30		
200	8"	204	IM411200	224,70	IM416200	227,35			IM611200	272,95	IM616200	290,70		
250	10"	254	IM411250	300,05	IM416250	311,10			IM611250	387,35	IM616250	430,65		
300	12"	304	IM411300	377,50	IM416300	458,30			IM611300	435,25	IM616300	555,00		

FLANGE COM COLARINHO CONFORME NORMA EN 1092-1 11

AISI 316L					
PN 10		PN 16		PN40	
COD.	€	COD.	€	COD.	€
IF624015	19,05	IF624015	19,05	IF624015	19,05
IF624020	33,30	IF624020	33,30	IF624020	33,30
IF624025	32,95	IF624025	32,95	IF624025	32,95
IF624032	45,80	IF624032	45,80	IF624032	45,80
IF624040	55,60	IF624040	55,60	IF624040	55,60
IF626050	65,80	IF626050	65,80	IF626050	65,80
I6633065	75,55	I6633065	75,55		
IF626065	75,55	IF626065	75,55		
IF626080	104,30	IF626080	104,30		
IF626100	125,95	IF626100	125,95		
IF626125	187,70	IF626125	187,70		
IF626150	224,45	IF626150	224,45		
		IF626200	334,95		
		IF626250	468,00		
		IF626300	618,50		
		IF626350	951,65		
		IF626400	1.189,65		
		IF626500	1.982,65		

DIMENSÕES			FLANGE ROSCADA CONFORME DIMENSÕES DIN 2576							
			AISI 304L				AISI 316L			
			PN 10-16		PN 40		PN 10-16		PN 40	
DN	POLG.	mm.	COD.	€	COD.	€	COD. DIN	€	COD. EN	€
15	1/2"	21,3	IR416015	17,35	IR416015	17,35	IR616015	20,25	IR616015	20,25
20	3/4"	26,9	IR416020	23,30	IR416020	23,30	IR616020	27,80	IR616020	27,80
25	1"	33,7	IR416025	28,25	IR416025	28,25	IR616025	34,05	IR616025	34,05
32	1 1/4"	42,4	IR416032	38,85			IR616032	47,90		
40	1 1/2"	48,3	IR416040	43,80			IR616040	52,75		
50	2"	60,3	IR416050	53,25			IR616050	69,60		
65	2 1/2"	76,1	IR416065	65,35			IR616065	92,75		
80	3"	88,9	IR416080	76,20			IR616080	109,35		
100	4"	114,3	IR416100	90,55			IR616100	119,85		

DIMENSÕES			FLANGE FORJADA ASME B 16.5 ASTM A182 - 150 LBS.					
			AISI 316L					
			WELDING NECK		SLIP ON		BLIND	
DN	POLG.	mm.	COD.	€	COD.	€	COD.	€
15	1/2"	21,3	IN150015	16,40	IO150015	12,95	IB150015	12,30
20	3/4"	26,9	IN150020	23,95	IO150020	20,90	IB150020	17,10
25	1"	33,7	IN150025	34,60	IO150025	25,05	IB150025	25,30
32	1 1/4"	42,4	IN150032	44,70	IO150032	33,70	IB150032	32,45
40	1 1/2"	48,3	IN150040	57,65	IO150040	54,20	IB150040	42,55
50	2"	60,3	IN150050	84,10	IO150050	64,15	IB150050	65,35
65	2 1/2"	76,1	IN150065	134,25	IO150065	103,70	IB150065	107,05
80	3"	88,9	IN150080	161,75	IO150080	119,40	IB150080	133,80
100	4"	114,3	IN150100	220,90	IO150100	160,00	IB150100	184,20
125	5"	139,7	IN150125	277,15	IO150125	182,25	IB150125	226,05
150	6"	168,3	IN150150	338,60	IO150150	221,00	IB150150	293,90
200	8"	219,1	IN150200	561,05	IO150200	360,20	IB150200	545,60
250	10"	273,0	IN150250	766,15	IO150250	492,20	IB150250	745,55



ATUSA PORTUGAL LDA

Rua Fernando Marques Dias, Lote 3

Zona Industrial Maia I Setor III

4470-391 MAIA - **PORTUGAL**

Tel.: +351 229410583

geral@atusagroup.com

www.atusagroup.com